



X-BT-GR, X-BT-MR, X-BT-ER

**New Generation Hilti X-BT-GR,
X-BT-MR and X-BT-ER Threaded
Fastener Specification**



CONTENT

1. Introduction	6
1.1 Definitions and general terminology	6
1.2 The new Generation X-BT system	6
1.3 X-BT system features and benefits – simplified fastening to steel	8
1.4 Installation method and anchoring mechanism	9
1.5 Grating, multi-purpose and grounding applications	9
2. Applications	11
2.1 Grating fastening system	11
2.2 Starter brackets of modular supports and MQ installation channel system	13
2.3 Fastening instrumentation, junction boxes and lighting	14
2.4 Fastening cable/conduit connectors	15
2.5 Fastening cable tray supports	15
2.6 X-BT-ER electrical connectors	16
3. Technical data	17
3.1 Product data	17
3.1.1 X-BT-GR and X-BT-MR material specification	17
3.1.2 X-BT-ER material specifications	17
3.1.3 Fastening tool	18
3.1.4 Approvals	18
3.2 Load data	19
3.2.1 Loads – Construction steel	19
3.2.2 Loads – cast iron base material*	20
3.2.3 Interaction formula	20
3.3 Application requirements and limits	21
3.3.1 Thickness of fastened material – X-BT-MR	21
3.3.2 Thickness of cable lug – X-BT-ER	21
3.3.3 Spacing and edge distances	21
3.3.4 Application limit/thickness of base material	21
3.3.5 Fastener selection and DX 351 fastening system components	22
3.3.6 Fastener selection and BX 3 fastening system components	22
3.3.7 Installation details – X-BT-MR	23
3.3.8 Installation for electrical connections – X-BT-ER	24
3.3.9 Fastening quality assurance	24
4. Method statement	25
4.1 Instructions for use - X-BT-MR M6/W6/10 SN 8	25
4.2 Instructions for use - X-BT-MR M8/14 SN 8	26

4.3 Instructions for use - X-BT-MR M10/W10/15 SN 8	27
4.4 Instructions for use - X-BT-GR M8/7 SN 8	28
4.5 Instructions for use - X-BT-ER M8/M10/W10 SN 8	29
5. Performance (technical reports)	30
5.1 Nomenclature and symbols, design concepts	30
5.2 Static resistance of the new generation X-BT studs	32
5.2.1 Tensile load deformation behavior	32
5.2.2 Tension pull-out strength	33
5.2.3 Shear strength	34
5.2.4 Effect of edge distance and spacing on pull-out strength	35
5.2.5 Holding mechanisms of X-BT threaded studs	36
5.3 Corrosion resistance	37
5.3.1 X-BT threaded stud corrosion information	37
5.3.2 Contact corrosion – X-BT stainless steel stud in carbon steel	38
5.3.3 Corrosion data from field tests at Helgoland Island (North Sea)	39
5.4 Effect of X-BT threaded stud fastenings on steel base material	40
5.4.1 Net section efficiency	41
5.4.2 Fatigue classification in compliance with Eurocode 3	42
5.4.3 Approved fastigued detail categories	44
5.5 Technical data for X-BT fastenings made to cast iron	46
5.5.1 Cast iron specification	46
5.5.2 Grounding and bonding restrictions	46
5.5.3 Performance review	47
5.6 Vibration effects on X-BT threaded stud fastenings	49
5.7 Temperature resistance of X-BT threaded stud fastenings	51
5.8 X-BT-ER stainless steel threaded studs electrical performances	53
5.8.1 Survey of tests and reference to separate X-BT-ER data sheet	53
5.8.2 Effect of X-BT-ER fasteners on integrity of pipe flanges	53
5.9 X-BT in stainless steel base material	54
5.10 X-BT under shock loading	55
5.11 X-BT stud in steel with a thickness of less than 8 mm	56
5.11.1 Pull-out capacity in thin steel	56
5.11.2 Shear load capacity in thin steel	56
5.12 X-BT on structural steel with passive fire protection (PFP) coating	57
5.12.1 Introduction	57
5.12.2 Features and benefits	57
5.12.3 Fastener program	58
5.12.4 Fastener and standoff adapter combinations	59

5.12.5 Installation information	60
5.12.6 Standoff adapter material specifications and dimensions	64
5.12.7 Corrosion information	64
5.12.8 Load data with standoff adapter	65
5.12.9 Method statement – Instruction for use	66
5.13 Chemical resistance of SN sealing washer	67

GLOSSARY ON NEW PRODUCT DESIGNATION

- X- ... Letter indicating Direct Fastening DX solution
- BT... Blunt Tip stud
- G, M, E ... Grating fastener, Multi-purpose fastener or Electrical connector
- R ... identifies corrosion resistant material
- M6/W6/M8/M10/W10 ... thread type and size
- 3/7/10/14/15 ... maximum thickness of fixed material [mm]
- SN ... sealing washer with steel cap and neoprene rubber
- 8 ... minimum base material thickness [mm] without damage of backside coating

Example:

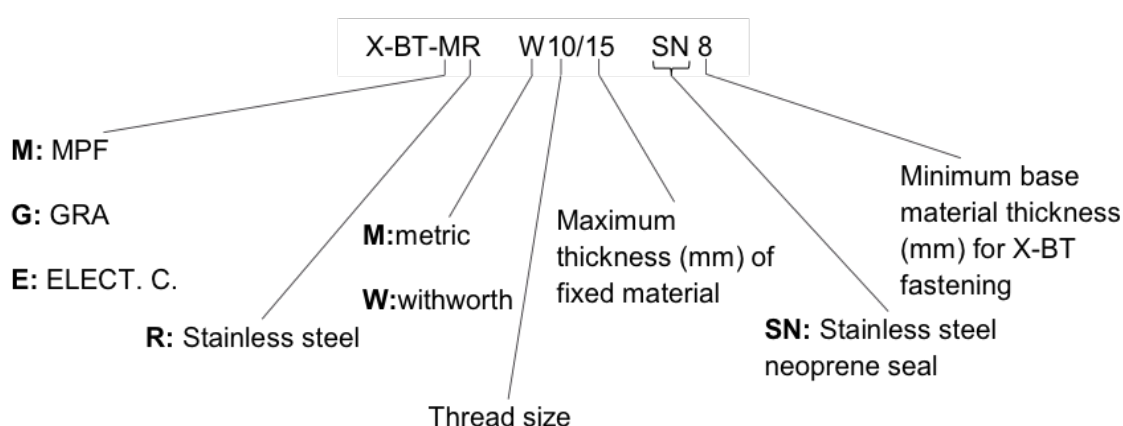

PREFACE TO THE NEW EDITION, JANUARY 2024

This new edition January 2024 is a further update of the first edition of the "New Generation X-BT-GR, X-BT-MR and X-BT-ER Threaded Fastener Specification" from June 2018.

Previous changes (Edition July 2019) addressed the addition of the new battery-actuated fastening tool BX 3-BT(G), which allows combustion free installation of the X-BT threaded fasteners. All performance data of the new generation X-BT threaded fasteners remained unchanged.

Besides the editorial update, the main changes of this current edition January 2024 are:

- Update of the X-BT stud portfolio
- Addition of standoff adapters (section 5.12)
- Consolidation of performance information on electrical connectors X-BT-ER into a separate data sheet

1. INTRODUCTION

1.1 Definitions and general terminology

Hilti direct fastening technology is a technique in which specially hardened nails or studs are driven into steel, concrete or masonry by a piston-type tool. Materials suitable for fastening by this method are steel, wood, insulation and some kinds of plastic. Fastener driving power is generated by a power load (a cartridge containing combustible propellant powder, also known as a “booster”), combustible gas or by battery. During the driving process, base material is displaced and not removed. In Hilti terminology, DX stands for “powder-actuated” systems like the DX 351 BT(G), and BX stands for “battery-actuated” systems like the new BX 3-BT(G).

1.2 The new Generation X-BT system

X-BT-GR for fastening of grating and X-BT-MR for multi-purpose fastenings

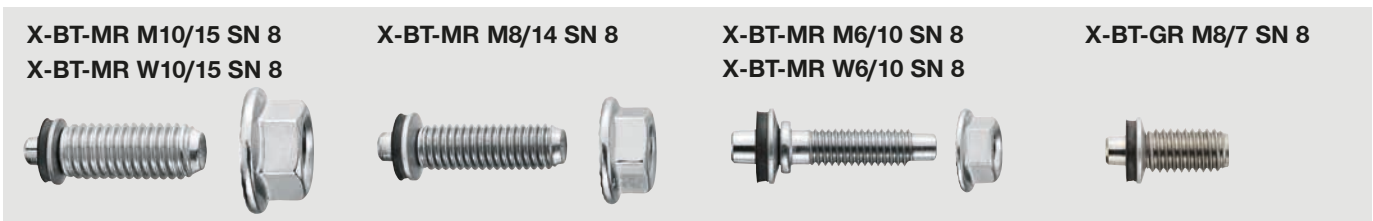

X-BT-ER stainless steel threaded stud for electrical connections



Tools and components



Cartridges and drill bits for DX



BX 3-BT – For X-BT-MR and X-BT-ER**X-FG B3-BT M****X-FG B3-BT W****BX 3-BTG – For X-BT-GR M8/7 SN 8 stud****X-FG B3-BTG****Battery and drill bits for BX****B 22/2.6**

Also allowed

B 22/3.0, B 22/4.0, B 22/5.2**TX-BT 4.7/7-80****TX-BT 4.7/7-110****TX-BT 4.7/7-150**

Since 2003 X-BT threaded fasteners have been successfully used in the market for applications in industrial and marine environment in the oil & gas as well construction industry. In 2018, the new generation X-BT fasteners X-BT-GR, X-BT-MR and X-BT-ER – as presented in this document – replaced the X-BT fasteners launched 2003, which will be referenced in this document as "previous generation X-BT fasteners".

This specification of the new generation X-BT threaded fasteners builds on the comprehensive knowledge foundation established and proven for the previous X-BT generation, as presented in the Hilti X-BT Threaded Fastener Specification, July 2015. New technical content will be presented in this specification to support the increased tension, shear and bending resistance of the new generation X-BT studs. When appropriate, reference will be made to the knowledge foundation of the previous generation of X-BT fasteners.

New generation X-BT

Item number	Designation
2252199	Threaded stud X-BT-MR M6/10 SN 8
2252470	Threaded stud X-BT-MR W6/10 SN 8
2194339	Threaded stud X-BT-MR M8/14 SN 8
2194340	Threaded stud X-BT-MR M10/15 SN 8
2194341	Threaded stud X-BT-MR W10/15 SN 8
2194344	Threaded stud X-BT-GR M8/7 SN 8
2252195	Electrical connector X-BT-ER M6/3 SN 8
2252198	Electrical connector X-BT-ER W6/3 SN 8
2194351	Electrical connector X-BT-ER M8/7 SN 8
2194352	Electrical connector X-BT-ER M10/7 SN 8
2194353	Electrical connector X-BT-ER W10/7 SN 8



Rework



Corrosion



Through-penetration



Loosening

1.3 X-BT system features and benefits – simplified fastening to steel

No rework

Stud welding or through-bolting may require reworking of the protective surface coating. With X-BT, the stud is set into a small pre-drilled hole and the drill entry point is then completely sealed by the stud washer during setting.

Simple and fast

A minimal amount of training is all that's required for a user to be able to drive up to 100 studs per hour.

High corrosion resistance

X-BT studs are made of high grade 1.4462 stainless steel (at least equivalent to grade 316 or A4), making them the right choice for almost every corrosive environment.

High loading and pull-out values

X-BT delivers performance comparable to methods such as stud welding.

Fasten to all steel shapes

Unlike clamps, which are limited by the configuration of the base steel, the X-BT is ideal for use on hollow sections, channel sections, wide flanges and angles.

Fasten to all steel grades

In addition to fastening to standard construction steel, the X-BT can also be used to fasten to high strength and thick steel.

Portable

The fastening tool's self-contained energy source eliminates the need for electrical cords and heavy welding equipment.

No through-penetration

The special process of drilling and driving results in secure fastening of the stud without through-penetration of the base material.

1.4 Installation method and anchoring mechanism

The blunt-tipped new generation X-BT-GR, X-BT-MR and X-BT-ER threaded studs have a conical shank with a mean shank diameter of 5.2 mm and are driven into a pre-drilled 4.7 mm diameter hole. This leads to displacement of the base material. Part of the base steel is punched down into the pre-drilled hole, generating high temperatures and causing friction welding. Displaced base material can be seen in the photograph. Predominant anchorage mechanism is fusion of the stainless steel material with the base material. Base material adhering to the fastener shank observed from pullout tension tests clearly indicated the fusion (friction welding) effect.

(For more details regarding installation, please refer to section 4 – Method statement)



Displaced base material

1.5 Grating, multi-purpose and grounding applications

Metal / fiberglass grating to steel for upstream and high corrosion environment



- X-BT-GR M8
- X-FCM-R HL
- X-FCM-R
- X-FCS-R

Fastening Hilti MQ installation channel system, metal brackets, clips, metal tracks, etc. to steel



- X-BT-MR M10
- X-BT-MR W10
- X-BT-MR M8
- X-BT-MR M6
- X-BT-MR W6

Mechanical and electrical for petro chemical industry, shipbuilding, etc.



- X-BT-MR M10
- X-BT-MR W10
- X-BT-MR M8
- X-BT-MR M6
- X-BT-MR W6

Functional and protective bonding and lightning protection



- X-BT-ER M10
- X-BT-ER W10
- X-BT-ER M8
- X-BT-ER M6
- X-BT-ER W6

2. APPLICATIONS

2.1 Grating fastening system

X-BT-GR M8/7 SN 8, X-FCM-R HL, X-FCM-R, X-FCS-R

An all stainless steel fastening system designed for attaching metal and fiberglass grating to coated steel and/or high-strength steel

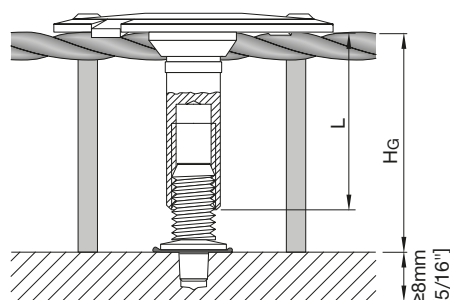
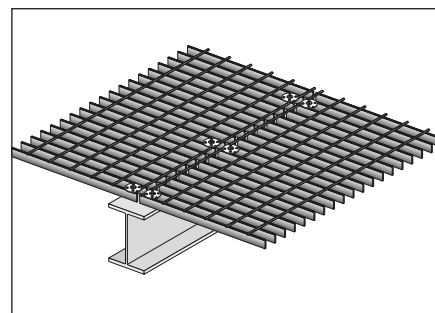

Thickness t of disc of X-FCM-R fasteners:
 X-FCM-R HL: $t = 1.5 \text{ mm}$
 X-FCM-R: $t = 1.25 \text{ mm}$

The X-FCM-R HL grating fastener allows higher tension and shear load resistance than the X-FCM-R grating fastener. The X-FCM-R HL grating fastener is designed to use the higher T of 20 Nm in combination with the new generation X-BT-GR M8/7 threaded stud.

Note: The longer X-BT-MR M8/14 SN 8 is not intended to be used for grating fastenings.

X-SEA-R 30 M8 extension adaptor

For use with X-FCM-R and X-FCM-R HL grating fasteners for fastening of grating with a height beyond 53 mm/2.09 in.

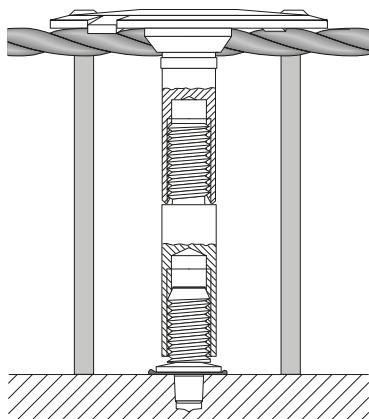

X-FCM-R (HL) grating disc

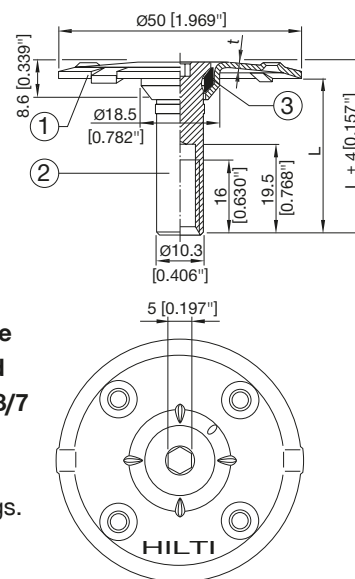

Outer diameter of the 2 tabs pressed into disc: 52 mm

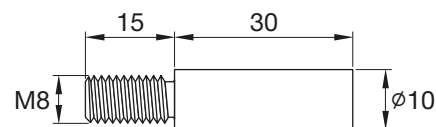

Fastener selection of X-FCM-R HL grating fasteners

Designation	Length L [mm/in.]	Grating height, h_g [mm/in.]	Grating height with X-SEA-R 30 M8 h_g [mm/in.]
X-FCM-R HL 23/28	18/0.71	23 – 28/0.91 – 0.98	53 – 58/2.09 – 2.16
X-FCM-R HL 28/33	23/0.91	28 – 33/0.98 – 1.18	58 – 63/2.16 – 2.36
X-FCM-R HL 32/37	27/1.06	32 – 37/1.14 – 1.34	62 – 67/2.32 – 2.52
X-FCM-R HL 38/43	33/1.30	38 – 43/1.38 – 1.57	68 – 73/2.56 – 2.75
X-FCM-R HL 48/53	43/1.69	48 – 53/1.77 – 1.97	78 – 83/2.91 – 3.15

With regards to more details of X-FCM-R HL and other grating fasteners X-FCM-R, X-FCM-R L, X-FCM-R NG, X-FCM-F, X-FCM-F L, X-FCM-F NG and X-FCS-R refer to the Hilti Direct Fastening Technology Manual.

Installation instructions

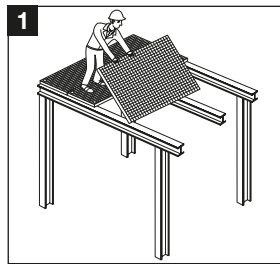

1 Lay grating section in final position.

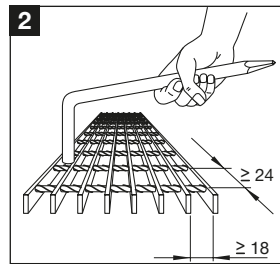

2 Expand grating openings if necessary.

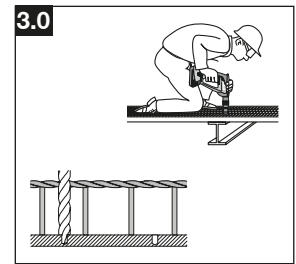

3.0 Pre-drill with **TX-BT 4.7/7** step shank drill bit.

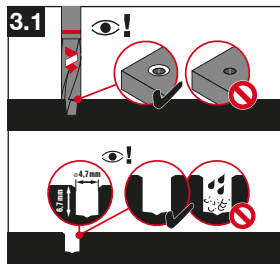

3.1 Pre-drill until shoulder grinds a shiny ring. The drill hole and the area around drilled hole must be clean and free from liquids and debris.

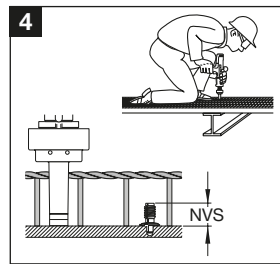

4 Drive fastener with **BX 3-BTG** tool or **DX 351 BT G** tool and 6.8/11 M brown cartridge.

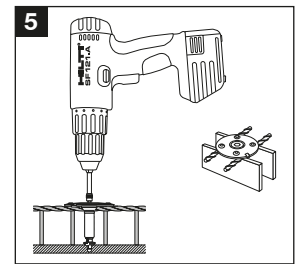

5 Tighten **X-FCM-R (HL)** with 5 mm Allen-type bit.

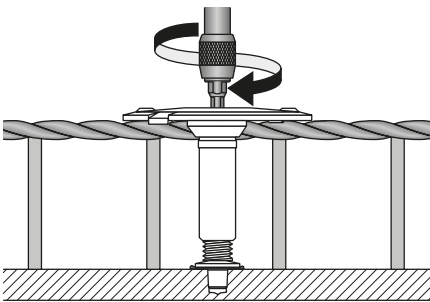

Installation details

Hand start to ensure no cross threading, then tighten using screwdriver with torque clutch.

Tightening torque for X-FCM-R HL high load grating fasteners: $T = 20 \text{ Nm}$ [14.8 ft-lb]
 Tightening torque for X-FCM-R grating fasteners: $T = 5 - 8 \text{ Nm}$ [3.7 - 5.9 ft-lb]

Tightening tool:

- Screwdriver with torque release coupling (TRC)
- 5 mm Allen-type bit
- Hilti torque tool X-BT ¼" - 20 Nm [14.8 ft-lb]
- Hilti torque tool X-BT ¼" - 8 Nm

Hilti screwdriver

With regards to suitable Hilti screwdrivers and their torque settings see the information given in the Hilti Direct Fastening Technology Manual for the respective grating fasteners or the information given in the instruction for use which is supplied with the respective grating fastener.

2.2 Starter brackets of modular supports and MQ installation channel system

Fastening of starter brackets of modular supports for pipes or cable trays, such like Hilti or Oglænd systems.

In case of applied shear load in the direction of slotted MQ channels, the X-BT should be placed according to the illustration below (end of slotted hole).

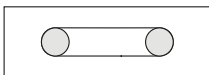

Two **X-BT** studs in one slotted hole



One **X-BT** stud in each slotted hole

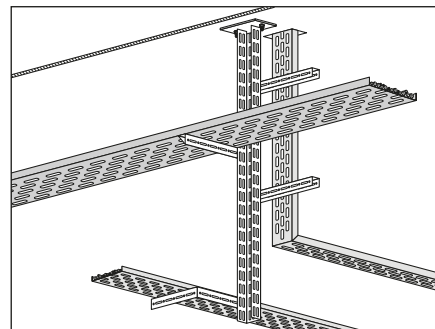

Modular support for cable trays

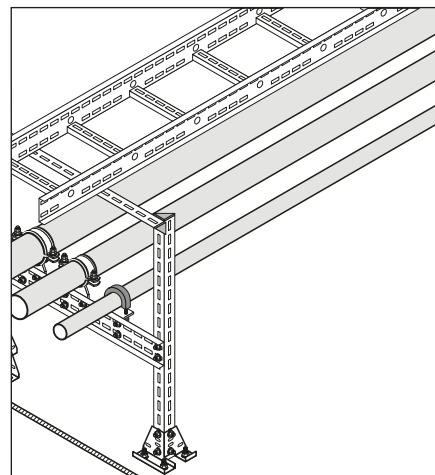

Modular support for pipes

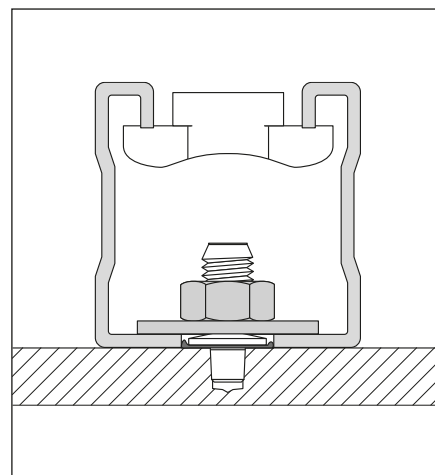

Fastening MQ channels

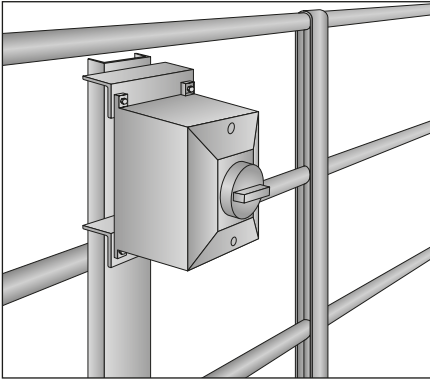

2.3 Fastening instrumentation, junction boxes and lighting

New generation X-BT stainless steel threaded stud for attaching instrumentation, junction boxes and lighting to coated steel and high-strength steel

Installation instructions

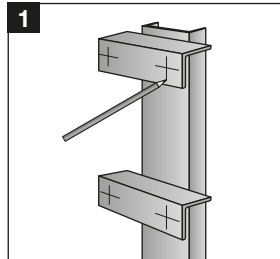

1
Mark location of each fastening.

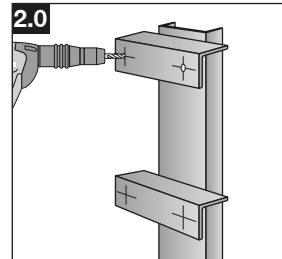

2.0
Pre-drill with **TX-BT 4.7/7** step shank drill bit.

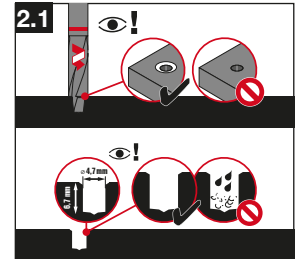

2.1
Pre-drill until shoulder grinds a shiny ring. The drill hole and the area around drilled hole must be clean and free from liquids and debris.

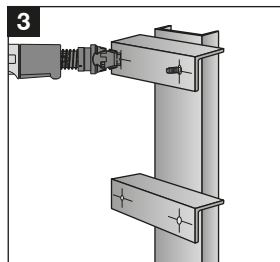

3
Drive X-BT fasteners with **BX 3-BT** tool or **DX 351 BT** tool and 6.8/11 M brown cartridge.

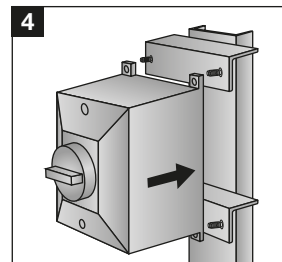

4
Position unit on studs and hold in place. Fit washers and start tightening by hand to avoid cross threading.

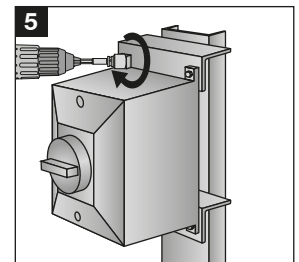

5
Tighten using a screwdriver with torque clutch or Hilti torque tool X-BT 1/4" - 20 Nm [14.8 ft-lb]
T ≤ 20 Nm (≤ 14.8 ft-lb)

2.4 Fastening cable/conduit connectors

New generation X-BT threaded stud for cable/conduit connectors.
 Stainless steel threaded stud for fastening cable and conduit connectors (T-bars) to coated steel and/or high-strength steel

Installation instructions

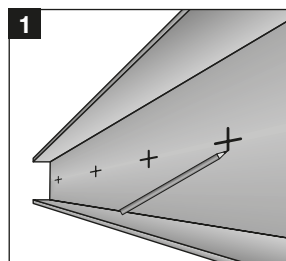

1 Mark location of each fastening.

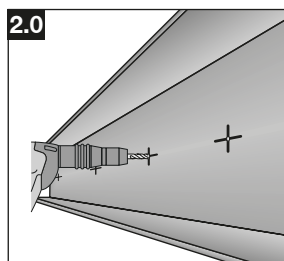

2.0 Pre-drill with **TX-BT 4.7/7** step shank drill bit.

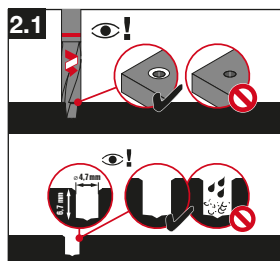

2.1 Pre-drill until shoulder grinds a shiny ring. The drill hole and the area around drilled hole must be clean and free from liquids and debris

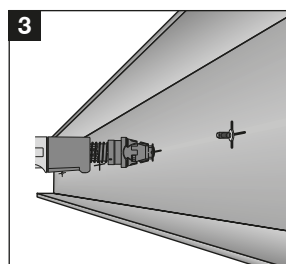

3 Drive X-BT fasteners with **BX 3-BT** tool or **DX 351 BT** tool and 6.8/11M brown cartridge.

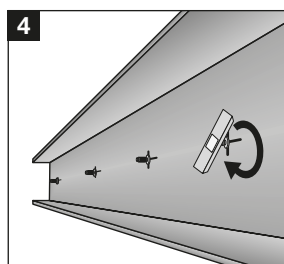

4 Screw on the connector and hand tighten. $T \leq 20 \text{ Nm}$ ($\leq 14.8 \text{ ft-lb}$)

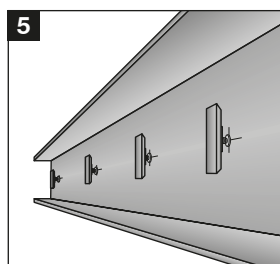

5 Align connectors.

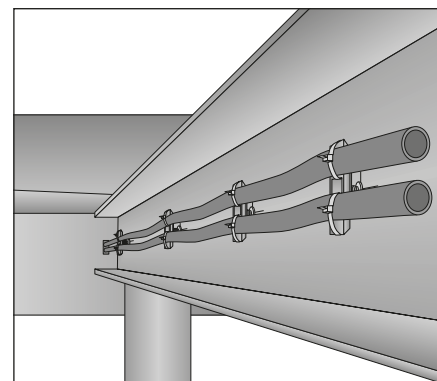

2.5 Fastening cable tray supports

New generation X-BT stainless steel stud for fastening cable trays to coated and / or high-strength steel

Installation instructions

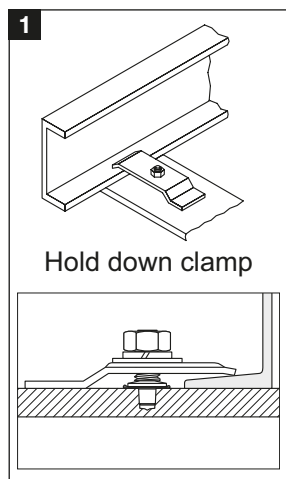

1 Hold down clamp

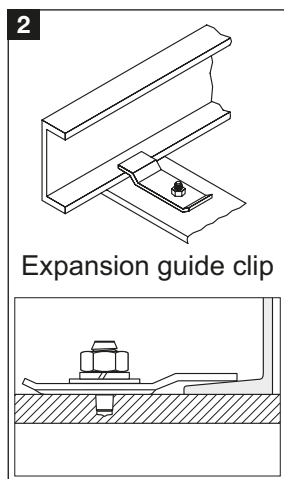

2 Expansion guide clip

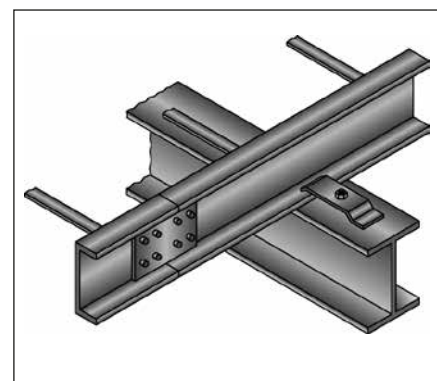

2.6 X-BT-ER electrical connectors

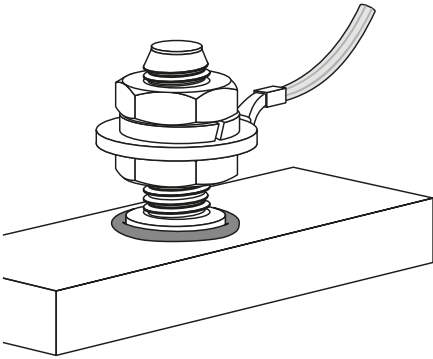

The X-BT-ER electrical connectors are used

- for functional bonding and terminal connection in a circuit
- as protective bonding circuit and
- for lightning protection.

For performance information it is referred to the separate X-BT-ER product data sheet (X-BT-ER - Stainless steel threaded stud for electrical connection) provided as part of the Hilti Direct Fastening Technology Manual.

3. TECHNICAL DATA

3.1 Product data

3.1.1 X-BT-GR and X-BT-MR material specification

X-BT-MR M10/15 SN 8
X-BT-MR W10/15 SN 8

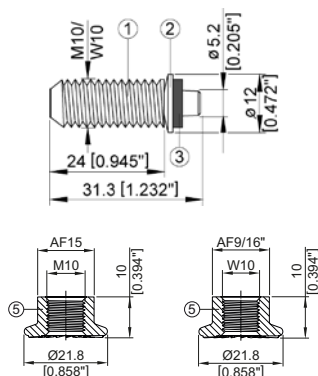

X-BT-MR M8/14 SN 8

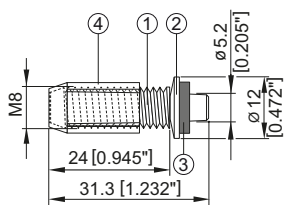

X-BT-MR M6/10 SN 8
X-BT-MR W6/10 SN 8

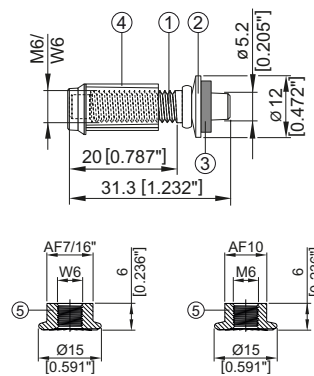

X-BT-GR M8/7 SN 8

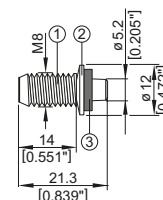

- ① Shank and thread: Stainless steel:
EN 1.4462, AISI 318LN, UNS S31803, X2CrNiMoN22-5-3
- ② SN washers: Stainless steel:
EN 1.4404, AISI 316L, UNS S31603, X2CrNiMo17-12-2
- ③ Sealing washers: Elastomer, black, resistant to UV, salt water, water,
ozone, oils, etc.
- ④ Guiding sleeve: Plastic
- ⑤ Flange nut: Stainless steel:
A4, AISI grade 316 material

Designation according to Unified Numbering System (UNS)

3.1.2 X-BT-ER material specifications

X-BT-ER M10/7 SN 8
X-BT-ER W10/7 SN 8

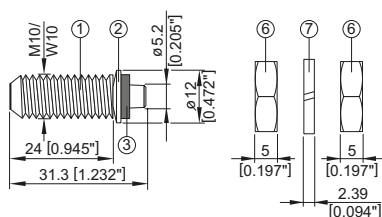

X-BT-ER M8/7 SN 8

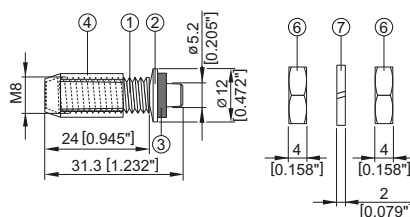

X-BT-ER M6/3 SN 8
X-BT-ER W6/3 SN 8

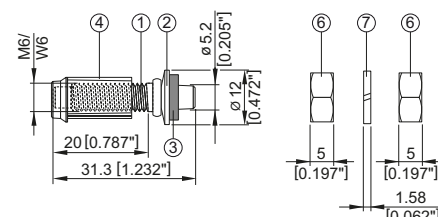

- ① Shank and thread: Stainless steel:
EN 1.4462, AISI 318LN, UNS S31803, X2CrNiMoN22-5-3
- ② SN washers: Stainless steel:
EN 1.4404, AISI 316L, UNS S31603, X2CrNiMo17-12-2
- ③ Sealing washer: Elastomer, black, resistant to UV, salt water, water,
ozone, oils, etc.
- ④ Guiding sleeve: Plastic
- ⑤ Nut: Stainless steel:
A4, AISI grade 316 material
- ⑥ Lock washers: Stainless steel:
A4, AISI grade 316 material

3.1.3 Fastening tool

DX 351-BT / BTG, BX 3-BT / BTG, see fastener selection in section 3.3.5.

3.1.4 Approvals

ABS, DNV, LR, ICC-ES, UL, ETA



Such as the previous X-BT threaded fastener generation, the current new generation X-BT-GR, X-BT-MR and X-BT-ER fasteners hold several Type Approvals which are valid for the ship-building and off-shore industry, such as:

- ABS – American Bureau of Shipping
- DNV – Det Norske Veritas
- LR – Lloyds Register
- BV – Bureau Veritas
- Russian Maritime Register

Applications for uses in the construction industry are covered by the following approvals:

- ETA-20/1042 for Europe
- ICC-ES ESR-2347 for the US

Remark: ESR-2347 also covers seismic loading.

The UL-listing (File E257069) addresses the use of X-BT-ER as grounding and bonding equipment.

Current approvals can be downloaded from Hilti website or from the websites of most Certification Bodies.

3.2 Load data

3.2.1 Loads – Construction steel

Recommended loads – steel base material

Steel grades		S235, S275, A36	S355 to S960 ≥ Grade 50
Tension	N_{rec} [kN/lb]	3.6/810	4.6/1030
Shear	V_{rec} [kN/lb]	4.3/970	5.3/1190
Moment	M_{rec} [Nm/ft-lb]	20.0/14.8	20.0/14.8

Conditions for recommended loads

- Application of working load design concept (e.g. ASD).
- For unalloyed construction, off-shore and Shipbuilding steel: e.g. European grades according to EN 10025-4 or EN 10225, S690Q and S960Q according to EN 10025-6, US steel grade A36 and Grade 50.
- Minimum base material thickness $t_{II} = 8$ mm.
- Applicable for steel base materials up to a coating thickness of 500 μ m.
- Edge distance $c \geq 10$ mm [3/8"].
- In case of edge distance $6 \text{ mm} \leq c < 10$ mm, N_{rec} , V_{rec} and M_{rec} need to be reduced with the reduction factor $\alpha_c = 0.65$.
- Redundancy (multiple fastening) must be provided.

Remarks

- The recommended loads in the table refer to the resistance of the single fastener and need to be determined by static analysis from the loads F_N and F_V acting on the fastened part. Typical example is the need of consideration of prying forces, see example.
- Moments acting on the shank only need to be considered in case of a gap between the base and the fastened material.
- Global factor of safety for tension and shear load = 2.8 related to the characteristic resistance N_{Rk} and V_{Rk} .
- Global factor of safety for bending moment = 1.75 related to the characteristic plastic moment M_{Rk} of the shank.
- Effects of base metal vibration and stresses are considered.

Characteristic resistance – steel base material

Steel grades		S235, S275, A36	S355 to S960, ≥ Grade 50
Tension	N_{Rk} [kN/lbs]	10.0/2240	13.0/2920
Shear	V_{Rk} [kN/lbs]	12.0/2700	15.0/3360
Moment	M_{Rk} [Nm/ft-lb]	35.0/25.5	35.0/25.5

Design resistance - steel base material

Steel grades		S235, S275, A36	S355 to S960, ≥ Grade 50
Tension	N_{Rd} [kN/lbs]	5.0/1120	6.5/1460
Shear	V_{Rd} [kN/lbs]	6.0/1350	7.5/1680
Moment	M_{Rd} [Nm/ft-lb]	28.0/20.5	28.0/20.5

Supplemental conditions and remarks for design resistances

- Application of partial safety design concept (e.g. Eurocode steel design)
- Design resistances N_{Rd} and V_{Rd} are determined from the characteristic resistance N_{Rk} and V_{Rk} applying a partial safety factor $\gamma_M = 2.0$
- Design resistance M_{Rd} is determined from the characteristic resistance M_{Rk} applying a partial safety factor $\gamma_M = 1.25$

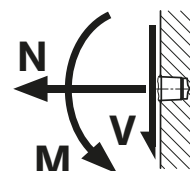

Example:

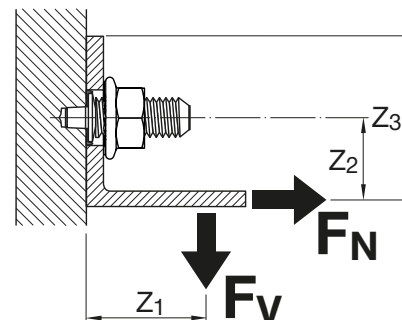

Provisions for group fastenings

For group fastenings with up to 4 fasteners per group and shear force introduction via the sealing washer (section 5.2.3), the resistance of all fastener can be added up, provided the hole in the fastened material is equal or less than 14 mm (e.g. $V_{rec,group} = 17.2$ kN for a group with 4 fasteners fixed to S235 base material).

3.2.2 Loads – cast iron base material*

Recommended loads – cast iron base material*

Tension	N_{rec} [kN/lb]	1.0/230
Shear	V_{rec} [kN/lb]	1.5/340
Moment	M_{rec} [Nm/ft-lb]	16.0/11.5

Design resistance – cast iron*

Tension	N_{Rd} [kN/lbs]	1.6/360
Shear	V_{Rd} [kN/lbs]	2.4/540
Moment	M_{Rd} [Nm/ft-lb]	26.0/19.0

*Requirements of spheroidal graphite cast iron base material

Subject	Requirements
Cast iron	Spheroidal graphite cast iron according to EN 1563
Strength class	EN-GJS-400 to EN-GJS-600 according to EN 1563
Chemical analysis and amount of carbon	3.3 - 4.0 mass percentage
Microstructure	From IV to VI (spherical) according to EN ISO 945-1:2010 Minimum size 7 according to figure 4 of EN ISO 945-1:2010
Material thickness	$t_{II} \geq 20$ mm

3.2.3 Interaction formula

Recommended interaction formula for combined loading - steel and cast iron base material

Load combination	Interaction provision
Shear - Tension	$\frac{V_{Sd}}{V_{Rd}} + \frac{N_{Sd}}{N_{Rd}} \leq 1.2$ with $\frac{V_{Sd}}{V_{Rd}} \leq 1.0$ and $\frac{N_{Sd}}{N_{Rd}} \leq 1.0$
Shear – Bending moment	$\frac{V_{Sd}}{V_{Rd}} + \frac{M_{Sd}}{M_{Rd}} \leq 1.2$ with $\frac{V_{Sd}}{V_{Rd}} \leq 1.0$ and $\frac{M_{Sd}}{M_{Rd}} \leq 1.0$
Tension – Bending moment	$\frac{N_{Sd}}{N_{Rd}} + \frac{M_{Sd}}{M_{Rd}} \leq 1.0$
Shear - Tension – Bending moment	$\frac{V_{Sd}}{V_{Rd}} + \frac{N_{Sd}}{N_{Rd}} + \frac{M_{Sd}}{M_{Rd}} \leq 1.0$

3.3 Application requirements and limits

3.3.1 Thickness of fastened material – X-BT-MR

- X-BT-GR M8: $2.0 \leq t_1 \leq 7 \text{ mm}$
- X-BT-MR M10/W10: $2.0 \leq t_1 \leq 15 \text{ mm}$
- X-BT-MR M8: $2.0 \leq t_1 \leq 14 \text{ mm}$
- X-BT-MR M6/W6: $2.0 \leq t_1 \leq 10 \text{ mm}^{*)}$

*) If base material sits on the collar of the stud $t_{1,\text{min}} = 1.0 \text{ mm}$

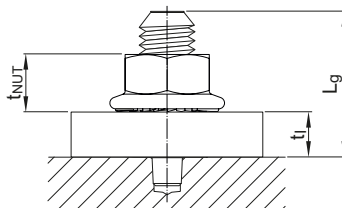

3.3.2 Thickness of cable lug – X-BT-ER

Electrical connector	Total cable lug thickness t_{cl} [mm]	Inner hole diameter d [mm]
X-BT-ER M6/3 SN 8	≤ 3	6.5
X-BT-ER W6/3 SN 8	≤ 3	6.5
X-BT-ER M8/7 SN 8	≤ 7	8.5
X-BT-ER M10/7 SN 8	≤ 7	10.5
X-BT-ER W10/7 SN 8	≤ 7	10.5

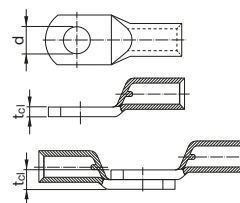

3.3.3 Spacing and edge distances

Edge distance:

$c \geq 10 \text{ mm}$ (load reduction factor $\alpha_c = 1.00$)

$6 \text{ mm} \leq c < 10 \text{ mm}$ (load reduction factor $\alpha_c = 0.65$)

Spacing:

$s \geq 15 \text{ mm}$

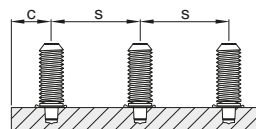

3.3.4 Application limit/thickness of base material

$t_{II} \geq 8 \text{ mm}$ [5/16"] \rightarrow No through-penetration. No limits with regard to steel strength.

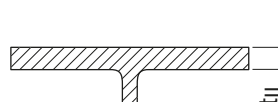

3.3.5 Fastener selection and DX 351 fastening system components

Fastener	Item number	Fastening tool	Fastening tool components	Cartridge	Step shank drill bit
X-BT-GR M8/7 SN 8	2194344	Tool: DX 351 BTG	Fastener guide: X-351-BT FG G (item no: 378675) Piston: X-351-BT P G (item no: 378677)	6.8/11 M brown High Precision (item no: 412689)	TX-BT 4.7/7-80 (item no: 2197930) TX-BT 4.7/7-110 (item no: 2197931) TX-BT 4.7/7-150 (item no: 2197629)
X-BT-MR M10/15 SN 8	2194340	Tool: DX 351 BT	Fastener guide: X-351-BT FG M1024 (item no: 378674) Piston: X-351-BT P 1024 (item no: 378676)		
X-BT-MR M8/14 SN 8	2194339				
X-BT-MR M6/10 SN 8	2252199				
X-BT-MR W10/15 SN 8	2194341	Tool: DX 351 BT	Fastener guide: X-351-BT FG W1024 (item no: 378673) Piston: X-351-BT P 1024 (item no: 378676)		
X-BT-MR W6/10 SN 8	2252470				
X-BT-ER M10/7 SN 8	2194352	Tool: DX 351 BT	Fastener guide: X-351-BT FG M1024 (item no: 378674) Piston: X-351-BT P 1024 (item no: 378676)		
X-BT-ER M8/7 SN 8	2194351				
X-BT-ER M6/3 SN 8	2252195				
X-BT-ER W10/7 SN 8	2194353				
X-BT-ER W6/3 SN 8	2252198				
X-BT-ER W6/7 SN 8	2194350				

Note:

- The three step shank drills only differ in their length. Their use depends on the accessibility condition on the jobsite.
- The recommended tool energy setting = 1 (if required, increase of energy setting based on job site tests).

3.3.6 Fastener selection and BX 3 fastening system components

Fastener	Item number	Fastening tool	Fastening tool components	Energy	Step shank drill bit
X-BT-GR M8/7 SN 8	2194344	Tool: BX 3-BTG	Fastener guide: X-FG B3-BTG (item no: 2197625)	Hilti's 22V cordless tool battery platform	TX-BT 4.7/7-80 (item no: 2197930) TX-BT 4.7/7-110 (item no: 2197931) TX-BT 4.7/7-150 (item no: 2197629)
X-BT-MR M10/15 SN 8	2194340	Tool: BX 3-BT	Fastener guide: X-FG B3-BT M (item no: 2197626)		
X-BT-MR M8/14 SN 8	2194339				
X-BT-MR M6/10 SN 8	2252199				
X-BT-MR W10/15 SN 8	2194341	Tool: BX 3-BT	Fastener guide: X-FG B3-BT W (item no: 2197627)		
X-BT-MR W6/10 SN 8	2252470				
X-BT-ER M10/7 SN 8	2194352	Tool: BX 3-BT	Fastener guide: X-FG B3-BT M (item no: 2197626)		
X-BT-ER M8/7 SN 8	2194351				
X-BT-ER M6/3 SN 8	2252195				
X-BT-ER W10/7 SN 8	2194353				
X-BT-ER W6/3 SN 8	2252198				
X-BT-ER W6/7 SN 8	2194350				

Note:

- The three step shank drills only differ in their length. Their use depends on the accessibility condition on the jobsite.
- The fastener guides of the battery-actuated tool BX 3-BT(G) also allow embedment depth adjustment: The front part can be turned to the positions 1, 2, 3 or 4 (Higher position leads to deeper embedment). The recommended start position is 3. If required, fine adjustment during job-site execution be applied.

3.3.7 Installation details – X-BT-MR

X-BT-MR M8

Fastened material:

- Hole diameter: 13 to 14 mm: Use of supplied flange nut ①
- Hole diameter: beyond 14 to 18 mm: Use of supplied flange nut with supplement washer (maximum thickness of fixed component to be reduced with thickness of washer) ②

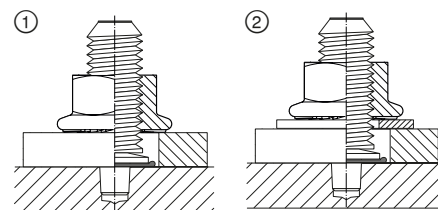

X-BT-MR M10/W10

Fastened material:

- Hole diameter: 13 to 18 mm: Use of supplied flange nut ①
- Hole diameter: beyond 18 to 22 mm: Use of supplied flange nut with supplement washer (maximum thickness of fixed component to be reduced with thickness of washer) ②

X-BT-MR M6/W6

Fastened material:

- Hole diameter: 6.5 – 6.7: Fastener sits on collar of stud, use of supplied flange nut ③
- Hole diameter: 6.7 to 11 mm: Use of supplied flange nut with supplement washer sitting on collar ④
- Hole diameter: > 12 mm, fixed part sits on base material, use of flange nut with supplemental washer to cover hole clearance (maximum thickness of fixed component to be reduced with thickness of washer) ②

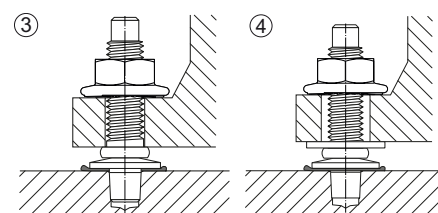

Provisions on group fastenings

For group fastenings with up to 4 fasteners per group and shear force introduction via the sealing washer (section 5.2.3), the resistance of all fasteners can be added up, provided the hole in the fastened material is equal or less than 14 mm.

For hole diameters in the fastened material greater than 14 mm, the following conservatively applies:

- For the shear load transfer only one fastener of the group may be considered (e.g. $V_{rec,group} = 4,3 \text{ kN}$ for any fastener group with ≥ 2 fasteners in S235 base material).
- If relevant, deformations have to be checked for serviceability reasons.

Before fastener installation

The drilled hole must be clear of liquids and debris. The area around the drilled hole must be free from liquids and debris. Pre-drill until the bit shoulder grinds a shiny ring (to ensure proper drilling depth).

Tightening torque information

Tightening torque $T_{rec} \leq 20 \text{ Nm}$ [14.8 ft-lb]

Hilti torque tool ¼" - 20 Nm / [14.8 ft-lb]

Remark: Recommended tightening torque for thin base material thickness $4 \leq t_{II} < 8 \text{ mm}$, see section 5.11.

Hilti screwdriver

With regards to suitable Hilti screwdrivers and their respective torque settings see the information given in the Hilti Direct Fastening Technology Manual or the information given in the instruction for use which are supplied with the fasteners.

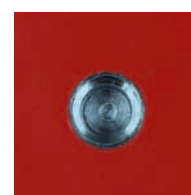

Pre-drilling

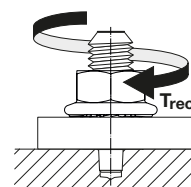

Installation temperature

Concerning the temperature range of the drilling tools SF BT 22-A or SF BT 18-A as well as the DX 351-BT(G) or BX 3-BT(G) fastening tools see the respective operating instructions.

Provided the tools are operated within their allowed range, fasteners can be driven into materials down to $-40\text{ }^{\circ}\text{C}$ base steel temperature. Condition here is, that the toughness specification of such base steels allows material use in that low temperature range.

3.3.8 Installation for electrical connections – X-BT-ER

Single point connection for X-BT-ER M6/3 SN 8, X-BT-ER W6/3 SN 8, X-BT-ER M8/7 SN 8, X-BT-ER M10/7 SN 8, X-BT-ER W10/7 SN 8

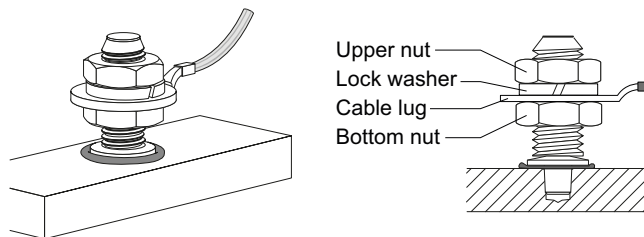

Double point connection for all X-BT-ER M8/7 SN8, X-BT-ER M10/7 SN 8, X-BT-ER W10/7 SN 8

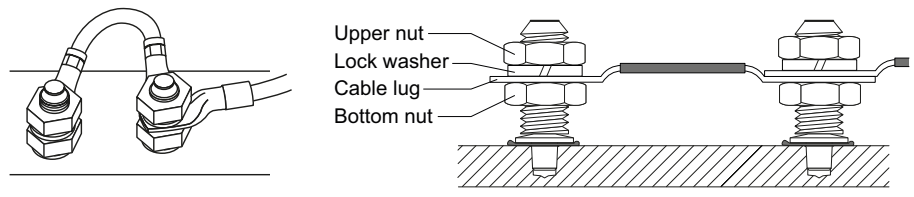

X-BT-ER fasteners can also be used in combination with adapters. Respective information is provided in the X-BT-ER product data sheet (X-BT-ER – Stainless steel threaded stud for electrical connection) provided as part of the Hilti Direct Fastening Technology Manual.

ALWAYS review/follow the instructions for use (IFU) accompanying the product.

3.3.9 Fastening quality assurance

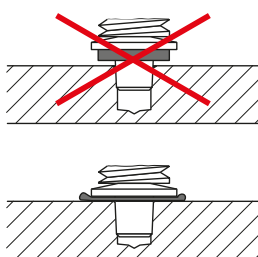

Fastening inspection

X-BT-GR M8

$h_{\text{NHS}} = 15.7 - 16.8\text{ mm}$

X-BT-MR M6/W6/M8/M10/W10

X-BT-ER M6/W6/M8/M10/W10

$h_{\text{NHS}} = 25.7 - 26.8\text{ mm}$

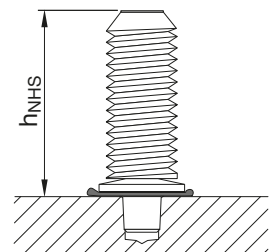

4. METHOD STATEMENT

4.1 Instructions for use - X-BT-MR M6/W6/10 SN 8

Fastening tool: DX 351-BT



X-BT-MR M6/W6

2259050-09.2022

CE
21
BIM AB FL-9484 Schaan
HB-CX-DOP-026
ETA-201042
EAD 333037-00-0602
0672
Threaded studs for connection of materials to structural steel

BUREAU VERITAS
TYPE APPROVED

RIIA
DNV
DNV-COMPLANT

Lloyd's Register
TYPE APPROVED

ABS
TYPE APPROVED

Use with

X-BT-MR M6/W6/10 SN 8	SF BT 22-A SF BT 18-A	K-BT 1/4" 14.8 mm	X-NSD 1/4" 20 Nm / 14.8 lb-ft	X-IG BT M6
X-BT-MR M6/W6/10 SN 8	DX 351-BT	X-NSD 1/4" 20 Nm / 14.8 lb-ft	X-IG BT W6	

Technical specifications:

- ≤ 0.5 mm / 0.02"
- ≥ 8 mm / 0.32"
- ≤ 0.5 mm / 0.02"
- ≤ 200 N
- T_{total} = 16-20 Nm

Fastening tool: BX 3-BT



X-BT-MR M6/W6

CE
21
BIM AB FL-9484 Schaan
HB-CX-DOP-026
ETA-201042
EAD 333037-00-0602
0672
Threaded studs for connection of materials to structural steel

BUREAU VERITAS
TYPE APPROVED

RIIA
DNV
DNV-COMPLANT

Lloyd's Register
TYPE APPROVED

ABS
TYPE APPROVED

Use with

X-BT-MR M6/W6/10 SN 8	SF BT 22-A SF BT 18-A	K-BT 1/4" 14.8 mm	X-NSD 1/4" 20 Nm / 14.8 lb-ft	X-IG BT M6
X-BT-MR M6/W6/10 SN 8	BX 3-BT	X-NSD 1/4" 20 Nm / 14.8 lb-ft	X-IG BT W6	

Technical specifications:

- ≤ 0.5 mm / 0.02"
- ≥ 8 mm / 0.32"
- ≤ 0.5 mm / 0.02"
- ≤ 150 N
- T_{total} = 16-20 Nm

Instructions for use are subject to continuous changes related to code developments, product portfolio updates, and new research results. Current instruction for use can be downloaded from Hilti website.

4.2 Instructions for use - X-BT-MR M8/14 SN 8

Fastening tool: DX 351-BT



X-BT-MR M8

2203795-09 2022

CE
21
Mini AB FL-9494 Schaan
Hilti-DX-DOP-008
ETA-20/1042
EAD 333037-00-0602
0672
Threaded studs for connection of materials to structural steel

Use with:

X-BT-MR M8/14 SN 8	SF BT 22-A	DX 351-BT	X-BT M-20Nm/14.8 lb-ft	S-NS 13 C 95/3 3/4"	X-AG BT M8
	SF BT 18-A				

Fastening tool: BX 3-BT



X-BT-MR M8

CE
21
Mini AB FL-9494 Schaan
Hilti-DX-DOP-008
ETA-20/1042
EAD 333037-00-0602
0672
Threaded studs for connection of materials to structural steel

Use with:

X-BT-MR M8/14 SN 8	SF BT 22-A	BX 3-BT	X-BT M-20Nm/14.8 lb-ft	S-NS 13 C 95/3 3/4"	X-AG BT M8
	SF BT 18-A				

Instructions for use are subject to continuous changes related to code developments, product portfolio updates, and new research results. Current instruction for use can be downloaded from Hilti website.

4.3 Instructions for use - X-BT-MR M10/W10/15 SN 8

Fastening tool: DX 351-BT



X-BT-MR M10/W10

2203796-09.2022

Use with	
X-BT-MR M10/15 SN 8	SF BT 22-A
X-BT-MR W10/15 SN 8	DX 351-BT
X-BT-MR W10/15 SN 8	S-NAS 15 C 253 3/4" M10
X-BT-MR W10/15 SN 8	S-NAS 15/2 C 253 3/4" XIG BT W10
X-BT-MR W10/15 SN 8	S-NAS 15/2 C 253 3/4" XIG BT W10

Fastening tool: BX 3-BT



X-BT-MR M10/W10

Use with	
X-BT-MR M10/15 SN 8	SF BT 22-A
X-BT-MR W10/15 SN 8	BX 3-BT
X-BT-MR W10/15 SN 8	S-NAS 15 C 253 3/4" M10
X-BT-MR W10/15 SN 8	S-NAS 15/2 C 253 3/4" XIG BT W10
X-BT-MR W10/15 SN 8	S-NAS 15/2 C 253 3/4" XIG BT W10

Instructions for use are subject to continuous changes related to code developments, product portfolio updates, and new research results. Current instruction for use can be downloaded from Hilti website.

4.4 Instructions for use - X-BT-GR M8/7 SN 8

Fastening tool: DX 351 BTG



X-BT-GR M8

2203797-09.2022

CE
21
Hilti AG, FL 9494 Schaan
Hilti-CH-0047-008
ETA-20/1042
EAD 333037-00-0602
0672
Threaded steel for connection of materials to structural steel

BUREAU VERITAS
TYPE APPROVED

Lloyd's Register
TYPE APPROVED

RINA

DNV
DNV-CLASSIFIED

ABS
CLASSIFIED

0-1km

Hilti
Corrosion handbook / SFTM

A4 316
Equivalent Corrosion Resistance

$\leq 0.5 \text{ mm} / 0.02''$
 $\geq 8 \text{ mm} / 0.32''$
 $\leq 0.5 \text{ mm} / 0.02''$

		Use with				
X-BT-GR MB / 7 SN 8	✓	SF BT 22-A / SF BT 18-A	DX 351 BTG	X-BT W-20 Nm / 14.8 lb-ft	S-NS 13 C Flange Nut MB 953 3/4"	X-HG BT MB

Fastening tool: BX 3-BTG



X-BT-GR M8

CE
21
Hilti AG, FL 9494 Schaan
Hilti-CH-0047-008
ETA-20/1042
EAD 333037-00-0602
0672
Threaded steel for connection of materials to structural steel

BUREAU VERITAS
TYPE APPROVED

Lloyd's Register
TYPE APPROVED

RINA

DNV
DNV-CLASSIFIED

ABS
CLASSIFIED

0-1km

Hilti
Corrosion handbook / SFTM

A4 316
Equivalent Corrosion Resistance

$\leq 0.5 \text{ mm} / 0.02''$
 $\geq 8 \text{ mm} / 0.32''$
 $\leq 0.5 \text{ mm} / 0.02''$

		Use with				
X-BT-GR MB / 7 SN 8	✓	SF BT 22-A / SF BT 18-A	BX 3-BT (G)	X-BT W-20 Nm / 14.8 lb-ft	S-NS 13 C Flange Nut MB 953 3/4"	X-HG BT MB

Instructions for use are subject to continuous changes related to code developments, product portfolio updates, and new research results. Current instruction for use can be downloaded from Hilti website.

4.5 Instructions for use - X-BT-ER M8/M10/W10 SN 8

The following graphs show the instructions for use for the items X-BT-ER M8/M10/W10 /7 SN 8. Instructions for use related with X-BT-ER M6/W6 /3 SN 8 are provided in the X-BT packages.

Fastening tool: DX 351-BT



X-BT-ER M8,
M10/W10 SN 8

2197511-09.2022

Fastening tool: BX 3-BT



X-BT-ER M8,
M10/W10 SN 8

Instructions for use are subject to continuous changes related to code developments, product portfolio updates, and new research results. Current instruction for use can be downloaded from Hilti website.

5. PERFORMANCE (TECHNICAL REPORTS)

5.1 Nomenclature and symbols, design concepts

The symbols and nomenclature used in the technical data are listed below.

Fastener test data and performance	
N and V	Tensile and shear forces in a general sense
F	Combined force (resulting from N and V) in a general sense
N_{Sk} and V_{Sk}	Characteristic tensile and shear forces (actions) acting on a fastening in a design calculation
N_{Sd} and V_{Sd}	Design tensile and shear forces (actions) acting on a fastening in a design calculation
N_u and V_u	Ultimate tensile and shear forces that cause failure of the fastening, statistically, the reading for one specimen
N_{u,m} and V_{u,m}	Average ultimate tensile and shear forces that cause failure of the fastening, statistically, the average for a sample of several specimens
s	The standard deviation of the sample
N_{Rk} and V_{Rk}	Characteristic tensile and shear resistance of the fastening, statistically, the 5%-fractile. For example, the 5%-fractile strength of a fastening whose ultimate strength can be described by a standard Gauss type distribution is calculated per test series by: $N_{5\%,t} = N_{u,m} - k \times s$ where k is a function of the sample size and the desired confidence level
N_{Rd} and V_{Rd}	Tensile and shear design resistance of the fastener
N_{rec} and V_{rec}	Recommended maximum tensile and shear loads of the fastener
M_{rec}	Recommended working moment of the fastener (statistically derived from the characteristic bending resistance M_{Rk})
Fastening details	
h_{ET}	Penetration of the fastener point below the surface of the base material
h_{NHS}	Fastener standoff above the surface fastened into
t_{II}	Thickness of the base material
t_i	Thickness of the fastened material
$\sum t_i$	Total thickness of the fastened material (where more than one layer is fastened)
t_{cl}	Total thickness of cable lug (for X-BT-ER)
Characteristics of steel and other metals	
f_y and f_u	Yield strength and ultimate strength of metals (in N/mm ² or MPa)

Design concepts

Partial safety factor concept (Eurocode, LRFD)

$$S_d \leq R_d$$

with:

$$S_d = \gamma_F \cdot S_k, \text{ and } R_d = \frac{R_k}{\gamma_{M,BT}}$$

S_d ... design action (internal forces and bending moment) acting on the stud
(N_{Sd} , V_{Sd} or M_{Sd})

S_k ... characteristic action acting on the stud (N_{Sk} , V_{Sk} or M_{Sk})

γ_F ... partial safety factor for actions

$$\gamma_F = 1.4 \text{ for general uses}$$

R_d ... design resistance of the stud (N_{Rd} , V_{Rd} or M_{Rd})

R_k ... characteristic resistance of the stud (N_{Rk} , V_{Rk} or M_{Rk})

$\gamma_{M,BT}$... partial safety factor of resistance for the new generation X-BT threaded studs

$$\gamma_{M,BT} = 2.0 \text{ in general}$$

$$\gamma_{M,BT} = 1.25 \text{ for bending of the stud itself}$$

Working load concept (ASD)

$$S_k \leq R_{rec}$$

with:

$$R_{rec} = \frac{R_k}{\gamma_{tot}} = \frac{R_k}{\gamma_{M,BT} \cdot \gamma_F} = \frac{R_k}{2.0 \cdot 1.4} = \frac{R_k}{2.8}$$

S_k ... characteristic action acting on the stud (N_{Sk} , V_{Sk} or M_{Sk}) =
Working load

Note on dead loads:

In many applications fasteners are stressed by the dead load of components. In that case the characteristic action (= working load) corresponds with the unfactored weight of the components supported by the X-BT threaded fasteners.

γ_{tot} ... total (global) safety factor

R_{rec} ... recommended service load values of the stud (N_{rec} , V_{rec} or M_{rec})

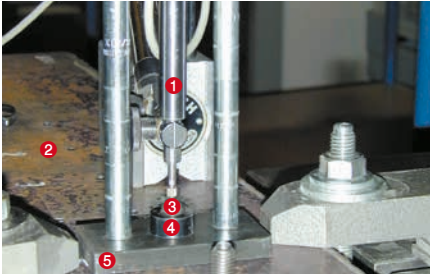

- ❶ Displacement sensor
- ❷ Base steel
- ❸ X-BT-M8/7 SN8
- ❹ Special nut, M10
- ❺ Loading plate

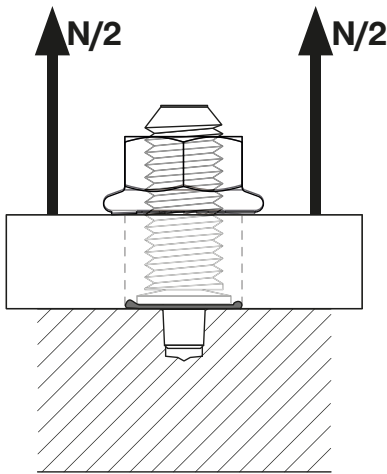

5.2 Static resistance of the new generation X-BT studs

5.2.1 Tensile load deformation behavior

Tension and shear tests with Hilti stud X-BT-GR M8/7 SN 8

Report 254/17, HTL-Rankweil (2017), Wechner W., 2017-12-04

Evaluation report on new generation Hilti X-BT-GR, X-BT-MR and X-BT-ER threaded fasteners,

Hilti Report XE-18-12, Beck H., 2018-05-22

Base material steel:

8 mm with $f_u = 427$ MPa (S235) and 15 mm with $f_u = 634$ MPa (S355)

Number of fastenings per series: 10

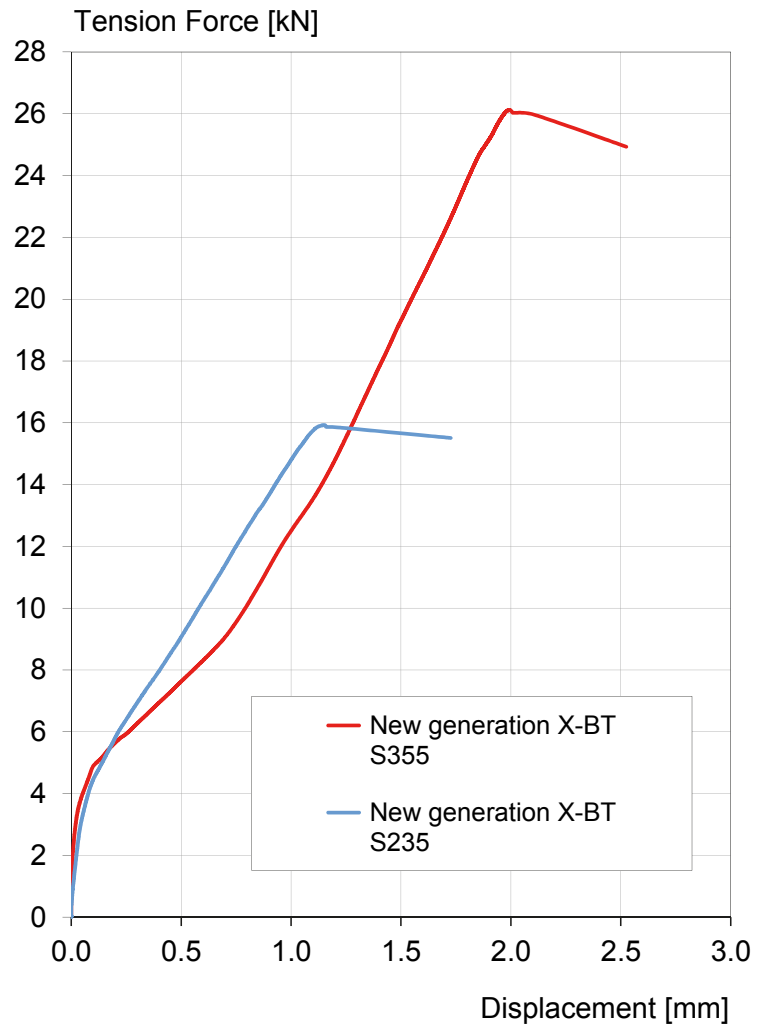

Conclusions

- Very high initial stiffness
- Sufficiently high deformations at ultimate load
- Ultimate pull-out loads increase with increasing base steel strength
- Load displacement characteristic is in well agreement with the observed friction welding anchoring mechanism

This summary is intended to be representative of the test(s) carried out. It is not intended to be a full and complete test report.

5.2.2 Tension pull-out strength

Evaluation report on new generation Hilti X-BT-GR, X-BT-MR and X-BT-ER threaded fasteners,

Hilti Report XE-18-12, Beck H., 2018-05-22

Base material steel: Thickness: 4, 6, 8, 12 and 15 mm, Grade: S235 up to S960

Coating thickness: $\geq 550 \mu\text{m}$

Number of fastenings per test: 10 or 20, in total 460 samples

Pull-out load depends on ultimate tensile strength of base material, relationship in uncoated steel:

Remark: Each data point represents the 5%-fractile $N_{5\%,t}$ of one test series

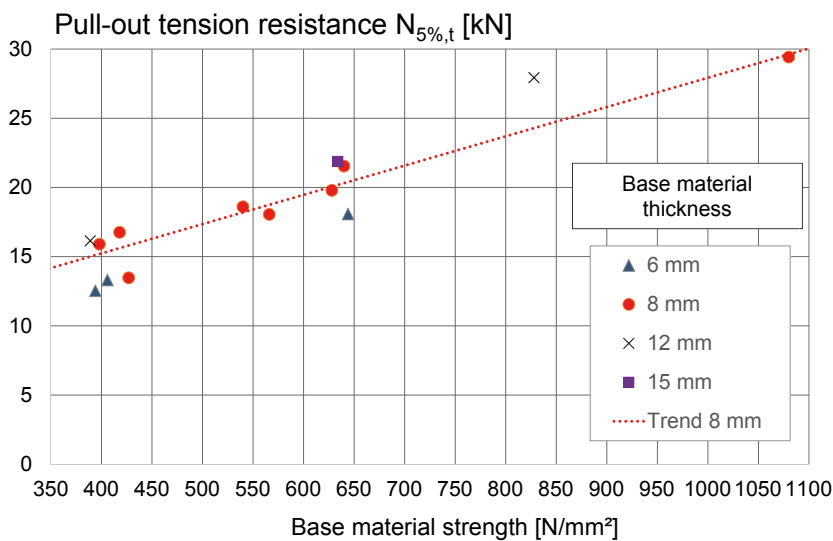
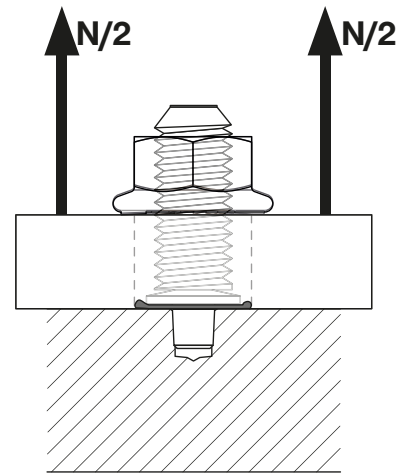

Conclusions

- Linear dependency of pull-out strength on the ultimate base steel strength.
- Even for low strength steel the 5% fractile of the pull-out resistance exceeds 10 kN.
- Little effect of base material thickness: Pull-out strength is independent on thickness for thickness ≥ 8 mm.
- Highest pull-out values achieved in high strength S960Q steel.

Effect of base material coating on pull-out strength:

Remark: Each data point represents the 5%-fractile $N_{5\%,t}$ of one test series

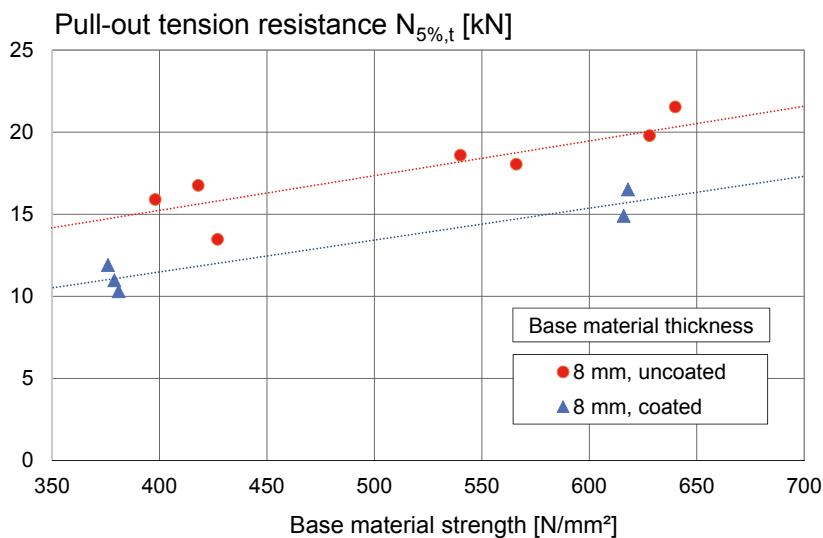

Conclusions

- Very reliable performance for coating thickness up to $500 \mu\text{m}$.
- Base material coating reduces pull-out strength due to reduced effective embedment in the base steel material.

This summary is intended to be representative of the test(s) carried out. It is not intended to be a full and complete test report.

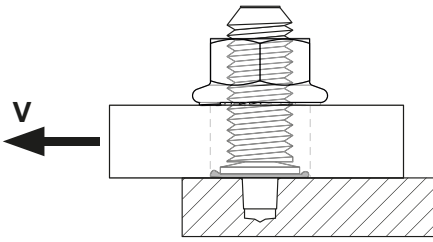

5.2.3 Shear strength

Tension and shear tests with Hilti stud X-BT-GR M8/7 SN 8

Report 254/17, HTL-Rankweil (2017), Wechner W., 2017-12-04

Evaluation report on new generation Hilti X-BT-GR, X-BT-MR and X-BT-ER threaded fasteners,

Hilti Report XE-18-12, Beck H., 2018-05-22

Base material steel: Thickness: 6, 8 and 15 mm, Grade: S235 and S355

Coated 8 mm steel: Coating thickness = 550 μm

Number of fastenings per test: 10, in total 40 samples

Load introduction via the sealing washer

The graphs below show the individual load displacement curves of all 10 test samples per respective test series.

Conclusions

- High shear strength achieved both in low strength and high strength steel.
- Failure mode in general pull-out of stud after local bending deformation.
- Coating covered up to 500 μm coating thickness.
- High ductility allowing full utilization of group fastenings up to 4 studs per group (with a hole clearance of 2.5 mm).
 - Condition is shear load introduction via the sealing washer.
 - The hole clearance of 2.5 mm corresponds with a hole diameter of 14 mm in the fastened material.

Load-displacement behavior: 8 mm, coated steel with $f_u = 376 \text{ MPa}$

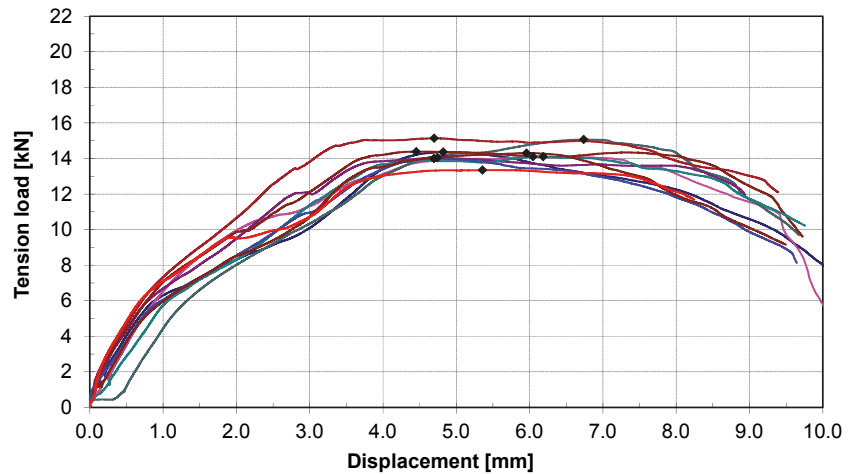

Load-displacement behavior: 15 mm, uncoated steel with $f_u = 632 \text{ MPa}$

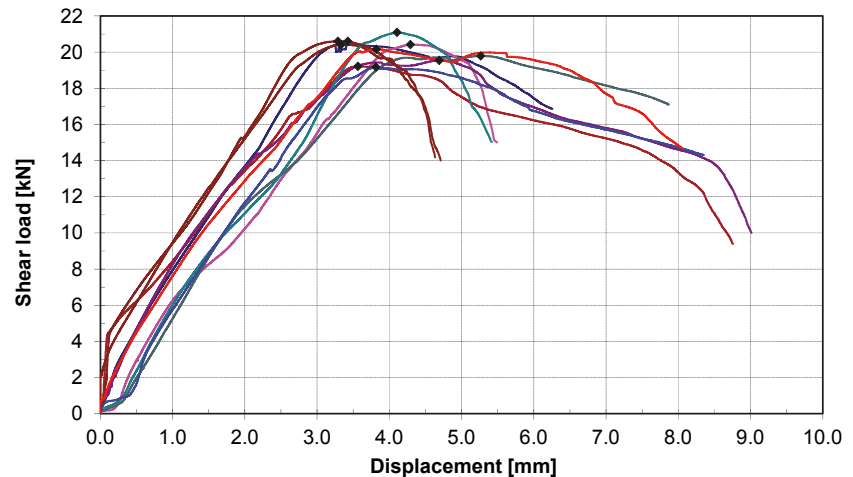

This summary is intended to be representative of the test(s) carried out. It is not intended to be a full and complete test report.

5.2.4 Effect of edge distance and spacing on pull-out strength

Evaluation report on new generation Hilti X-BT-GR, X-BT-MR and X-BT-ER threaded fasteners,

Hilti Report XE-18-12, Beck H., 2018-05-22

Edge distance

Base material steel: Thickness 20 mm, Grade S235 ($f_u = 435$ MPa), uncoated

Number of fastenings per edge distance: 20

Edge distances tested: 4, 5, 6, 7 and 8 mm

Test concept

- 1) Drive new generation X-BT fasteners at various edge distances
- 2) Pull out of all fasteners
- 3) Compare ultimate pull-out loads for the various fastenings

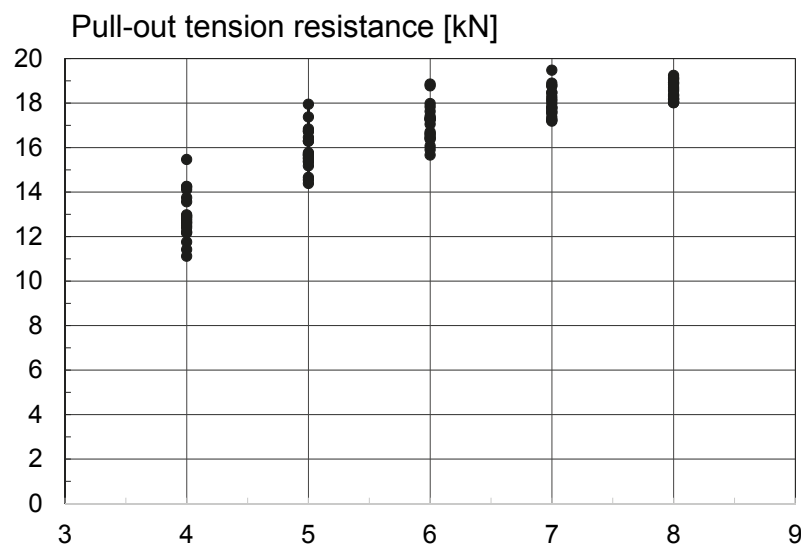
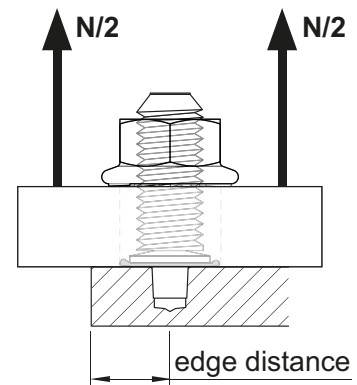

Conclusions

- Very robust behavior observed even at very close edge distance.
- Minimum edge distance of 6 mm clearly confirmed.

Fastener spacing

- Minimum fastener spacing of 15 mm is determined by the dimensions of the base plate of the DX 351 BT or DX 351 BTG tool.
- An increased spacing beyond 15 mm does not increase ultimate pull-out resistance (unchanged compared with the previous generation of X-BT threaded studs, see test data in the Hilti X-BT Threaded Fastener Specification, July 2015)
- A minimum fastener spacing of 15 mm is adequate to avoid reduction in recommended load.

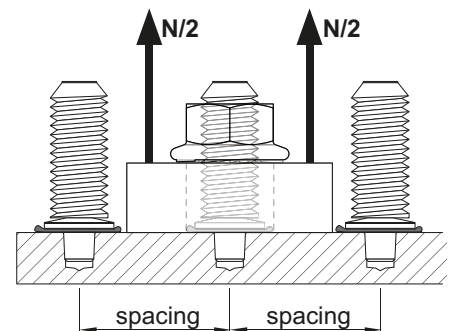

This summary is intended to be representative of the test(s) carried out. It is not intended to be a full and complete test report.

5.2.5 Holding mechanisms of X-BT threaded studs

Description of the holding mechanism

- The drill hole diameter of the pilot hole is smaller than the conical blunt tip of the X-BT threaded fastener. When driving the X-BT stud into steel, high temperatures develop along the contact surface between the tip of the X-BT fastener and the carbon steel base material. This process leads to predominant fusion of the stud with the base material due to friction welding.
- This mechanism is confirmed by metallurgical examination of the cross section as well as by visual investigation of pulled-out fasteners. Furthermore, the achieved tension pull-out resistance suggests that shear failure of the base material along the contact area with the tip controls the ultimate resistance.
- Due to this anchorage mechanism, the drilled hole below the tip of the X-BT threaded stud remains sealed.

View of pulled-out fastener

Base material attached to the pulled threaded fastener is clearly visible.



View of cross section 3 mm below top surface of base material

Metallurgical investigations confirm fusion due to friction welding along the entire perimeter.

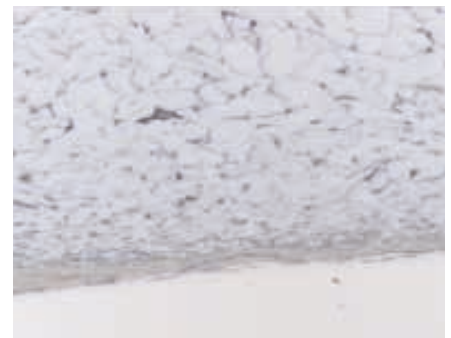
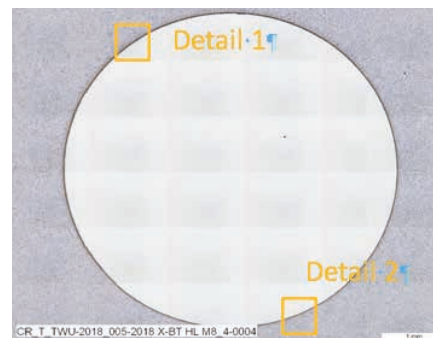

Detail 1, etched with 2 % Nital



Detail 2, etched with 2 % Nital

This summary is intended to be representative of the test(s) carried out. It is not intended to be a full and complete test report.

5.3 Corrosion resistance

5.3.1 X-BT threaded stud corrosion information

The new generation X-BT threaded fasteners maintain at least the same durability as the previous generation of X-BT threaded fasteners.

- Comprehensive investigations on the corrosion resistance of the previous generation of X-BT threaded fasteners were performed to assess the durability of the fastener in marine environment (test data see Hilti X-BT Threaded Fastener Specification, July 2015).
- The complete body of the new generation X-BT threaded fasteners is now made from ferritic-austenitic corrosion resistant duplex steel 1.4462. This material is known and recognized for reliable uses in marine environment. It has a Pitting Resistant Equivalent (PRE) of ≥ 34 (for comparison: A4 or 316 austenitic steel have a PRE of about 25).
- For the duplex steel 1.4462 the breakdown potential of the fasteners in artificial seawater – a very corrosive medium even for corrosion resistant steel – amounts to more than $1'200 \text{ mV}_{\text{SHE}}$. For comparison the pitting potential in artificial seawater of A4 or 316 austenitic steel amounts to about $800 \text{ mV}_{\text{SHE}}$.
- The reliable and proven concept of sealing the entrance location of the X-BT threaded stud with a sealing washer remained unchanged with the new generation threaded studs.
- Test samples of coated base material exposed to salt spray testing show no evidence of corrosion. The pullout resistance of the threaded fasteners is not affected by the exposure to the atmosphere.

Observations and examination from salt spray testing

After 480 hours of salt spray testing, the bottom side of the 8 mm [5/16"] steel plate was examined. No evidence of damage or corrosion could be found.

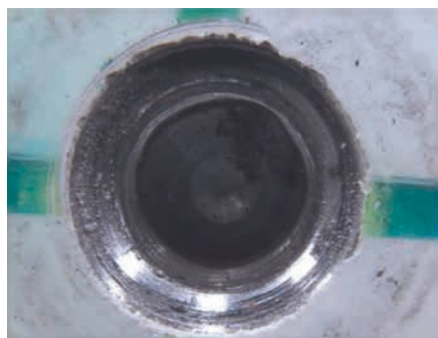

Drilled holes after 480 hours of salt spray test and after pull-out of the X-BT fasteners. These holes appear clean and no evidence of corrosion is visible.

Conclusions from the tests

- Tests confirm durability of the new generation X-BT threaded fasteners to be at least equivalent with the previous generation of X-BT threaded studs (described in Hilti X-BT Threaded Fastener Specification, July 2015)
- After salt spray tests no corrosion was found in the drilled holes. This is strong evidence that the sealing washer provides an effective seal.
- After salt spray tests, there was no evidence of corrosion on the bottom side of the steel plate. This shows that drilling the hole and driving the fastener does not cause damage on the bottom side.
- Corrosion resistant material 1.4462 covers all A4 or AISI grade 316 uses.

This summary is intended to be representative of the test(s) carried out. It is not intended to be a full and complete test report.

5.3.2 Contact corrosion – X-BT stainless steel stud in carbon steel

Test Report:

Corrosion behavior of stainless steel DX fasteners in carbon steel;

G. Felder and M. Siemers, Schaan, September 2005

When it comes to contact corrosion, the new generation X-BT threaded fasteners have same performance as the previous generation.

Therefore, the following section taken from the “X-BT Threaded Fastener Specification”, July 2015, fully applies for the new generation X-BT threaded fasteners.

General comments

Two materials of different resistance/polarity exposed to the same media, in direct electrical contact, lead to accelerated corrosion of an electrochemically “less noble” material in contact with a “noble” material. The material loss of the noble partner is reduced, the loss of surface area of the less noble partner is increased. Prerequisite for this form of corrosion is an electrically conductive connection between these two materials.

Whether contact corrosion occurs depends also on the **surface area ratio**.



If the surface of the less “noble” material (1) is greater than that of the more “noble” material (2), it will act as a very small cathode and the current density on the “large anodic” less noble material will be very small. Further, this also implies a very low rate of corrosion of the “less noble” material due to electrochemical effects.



However, if the surface of the less “noble” material (1) is smaller than that of the more “noble” material (2), the rate of corrosion of the “less noble” material will be very high.



Steel base material after 10 years of exposure to sea water and pull-out of the X-BT fastener. The hole appears clean and no evidence of corrosion is visible.

Hilti X-BT in carbon steel

Where stainless steels are concerned, contact corrosion is not a matter of concern. Stainless steels are higher in the galvanic series, i.e. more noble than most generally used materials such as aluminium, zinc and steel. Stainless steel in contact with these materials thus gains cathodic protection. Contact therefore generally has a favorable effect on the corrosion properties of stainless steels.

Due to the electrochemical effects as described above, the “noble” stainless steel fastener induces a very low rate of corrosion of the “less noble” base material and fastened material, or possibly no corrosion at all. This behavior has also been confirmed in a number of salt spray tests and in long-term tests with exposure to sea water in the tidal zone on an island in the North Sea.

In all of these tests, no corrosion occurred. The condition of a specimen after 10 years of sea water tests is shown in the photo on the left. No evidence of corrosion can be found at the anchoring zone of the X-BT fastener. The seal has remained fully functional, no electrolyte is present and contact corrosion is not an issue.

This summary is intended to be representative of the test(s) carried out. It is not intended to be a full and complete test report.

5.3.3 Corrosion data from field tests at Helgoland Island (North Sea)

Test reports:

Expert assessment: Investigation of the corrosion resistance of Hilti X-BT fasteners in marine atmospheres and in sea water,
9004742000 G/Bf; MPA, University of Stuttgart; Feb 3, 2014

Expert opinion: New Generation X-BT,
9034407000 /Bf; MPA, University of Stuttgart; Jan. 8, 2018

Due to the design of the new generation X-BT threaded fasteners, they offer at least comparable corrosion resistance as the previous generation of X-BT threaded fasteners.

Therefore, the following section – summarizing the field tests at Helgoland Island and taken from the “X-BT Threaded Fastener Specification”, July 2015 – fully applies for the new generation X-BT threaded fasteners:

Test material

Base material	S235 steel ($f_u = 439$ MPa), 8 mm thick
Number of specimens	24 steel plates, each with 18 X-BT studs

Test procedure

The test specimens were installed in May 2003 and samples taken periodically from each zone for assessment in June 2004, June 2005, May 2008 and April 2013.

Microscopic and metallurgical investigations to assess corrosion were carried out by MPA, University of Stuttgart. The tensile resistance tests were carried out by Hilti under supervision of the MPA.

Test results

Test specimens after 10 years of exposure to sea water in the tidal zone of the North Sea. No evidence of corrosion is visible on the X-BT studs and X-FCM discs. Only slight discoloration due to deposits can be observed on the X-FCM discs.

Conclusions

- After 10 years of exposure to sea water, no obvious signs of corrosion were found on the X-BT fasteners. After 10 years of exposure to sea water, no relevant signs of corrosion were found on the X-FCM fasteners.
- After 10 years of exposure to sea water, no corrosion was found in the drilled holes. This is strong evidence that the sealing washer provides an effective seal.
- Ultimate pull-out strength of the fasteners was not affected by the field tests. The pull-out load achieved in monitoring tests carried out in June 2003 was 8.6 kN, and in 2013 it was 10.3 kN (Note: These values refer to the previous generation of X-BT threaded fasteners).

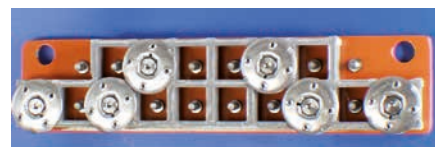

- 8 specimens in an atmospheric test rig in accordance with ISO 8565
- 16 specimens in a sea water testing rig, wave zone and tide zone, in accordance with ISO 11306



Marine atmosphere test rig with X-BT test specimens installed.



Sea water test rig with test specimens installed (X-BT with and without X-FCM grating discs).





Steel base material after 10 years of exposure to sea water and pull-out of the X-BT fastener. The hole appears clean and no evidence of corrosion is visible.



Based on the long-term tests carried out by the MPA as described above as well as the investigation of the new generation X-BT threaded studs, the University of Stuttgart (Expert Opinion 9034407000 / Bf; MPA, University of Stuttgart; Jan 8, 2018) came to the following conclusion:

It can thus be assumed that the new generation Hilti X-BT fasteners made from stainless steel are of at least comparable resistance under atmospheric corrosion conditions to the current X-BT studs. In atmospheres containing chloride ions, i.e. in atmospheres of the corrosivity categories C4 or C5 (C5-M), they can be assumed to have a life expectancy, from a corrosion point of view, of more than 40 years.

5.4 Effect of X-BT threaded stud fastenings on steel base material

Evaluation report on new generation Hilti X-BT-GR, X-BT-MR and X-BT-ER threaded fasteners,

Hilti Report XE-18-12, Beck H., 2018-05-22

Tensile tests for determination of mechanical properties: Flat-sheet specimens made of steel S235JR and P355NL1 without fastener, with one fastener of type X-BT-GR M8/7 SN8, with two fasteners of type X-BT-GR M8/7 SN8 and pulled out fastener respectively,

EMPA, Test report No 5214017148/e (2018): Swiss Federal Laboratories for Materials Testing and Research (EMPA), Dübendorf, Switzerland, January 16th 2018

Constant amplitude fatigue tests: Flat-sheet fatigue specimens made of steel S235 JR+N with correctly installed fasteners of the new generation type X-BT-GR M8/7 SN8, removed fasteners and drill hole respectively,

EMPA, Test report No 5214017145/3e (2018): Constant amplitude fatigue tests: Swiss Federal Laboratories for Materials Testing and Research (EMPA), Dübendorf, Switzerland, January 15th 2018

Fatigue classification of the constructional detail „Structural steel base material with the Hilti power-actuated threaded fasteners X-BT-GR and X-BT-MR”,

Kuhlmann, U., Günther, H.P. (2018): Report, University of Stuttgart, Institute for Construction and Design, 19.5.2018, Nr. 2018-13X

Base material (static tests):	Steel 8 and 10 mm, grade S235 and S355
Base material (fatigue tests):	Steel: 8, 20 and 40 mm, grade S235 and S960
Number of tests:	48 static tensile and 58 fatigue tests

5.4.1 Net section efficiency

Load-deformation behavior of steel with X-BT fasteners

Evaluated in tensile tests performed with coupons with X-BT fasteners, XE-18-12

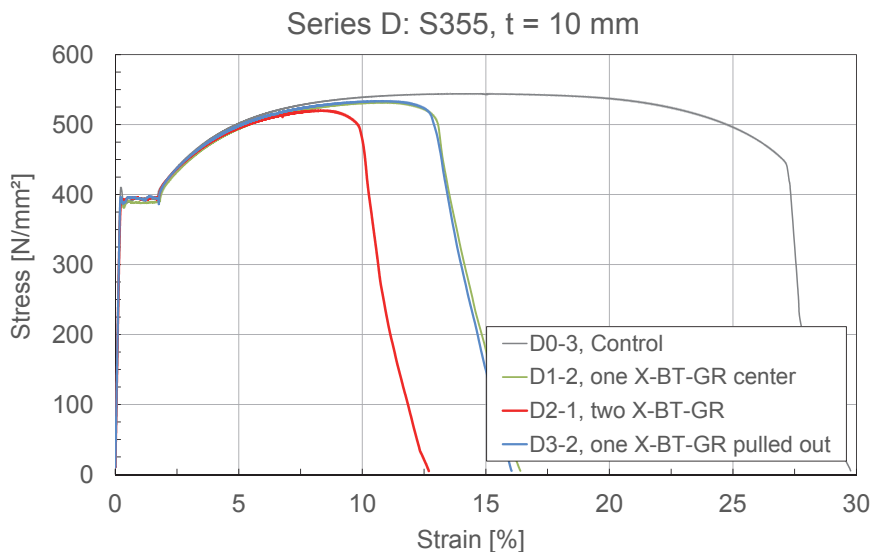

Conclusions

- Very high net section efficiencies – as observed with Hilti DX powder-actuated fasteners as well as with the previous generation of X-BT fasteners – also developed for plates with new generation X-BT threaded fasteners.
- The effect on the yield strength of the base material is negligible.
- Generally, the presence of an X-BT fastener need not be taken into account in the design of tensile members made of structural steel.
- In case of exceptionally high fastener concentrations (net area < 92 % of gross area according to AISC provisions) and if strict code compliance is required, application of the design provisions of AISC-LRFD or Eurocode 3 (EN 1993-1-1) for drilled holes leads to conservative designs (see in detail Section 2.7.1. of “Powder-actuated fasteners and fastening screws in steel construction” from the Stahlbaukalender 2019).

Use of X-BT-MR fasteners in bulb stiffeners of steel decks

Bulb stiffeners are widely used as stiffeners in orthotropic steel decks in vessel construction.

Based on the above experimental investigations on net section efficiency, there is no fundamental technical restriction which prevents the use of X-BT threaded fasteners to be driven into bulb stiffeners. Also the requirement on the minimum edge distance of 6 mm are observed even when using small bulb sections such as HP100x6.

However, the presence of the X-BT fastener on the bulb capacity is to be considered in the static design of the bulb. Options in that regards are

- to limit the use of the X-BT to areas along the bulb where the bulb is clearly not fully utilized.
- to design the bulb assuming the hole made by the X-BT as a drilled hole. The hole area to be considered amounts to 32 mm² (4.7x6.7mm). It depends on the procedures given in the relevant design code, if the fracture in the net failure will control versus yielding of the gross section.

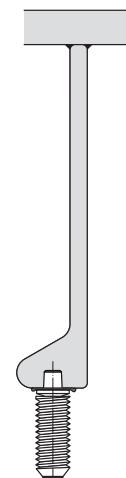

X-BT-MR fasteners driven into bottom face of bulb stiffeners

This summary is intended to be representative of the test(s) carried out. It is not intended to be a full and complete test report.

5.4.2 Fatigue classification in compliance with Eurocode 3 (EN 1993-1-9) "Structural steel base material with Hilti power-actuated fastener X-BT-GR, X-BT-MR and X-BT-ER"

Hilti ran already a comprehensive fatigue test program for the previous generation of X-BT threaded fasteners to classify the constructional detail "Structural steel base material with the Hilti powder-actuated fastener X-BT" in compliance with the Eurocode 3 (EN 1993-1-9). Results are summarized in the "X-BT Threaded Fastener Specification", July 2015.

Hilti complemented those investigations with a supplemental comprehensive fatigue test program with steel plates with installed new generation X-BT threaded fasteners. Those tests were again performed at EMPA (Swiss Federal Laboratories for Materials Testing and Research) in Dübendorf, Switzerland. The respective evaluation of the tests results was again made by Prof. U. Kuhlmann and Prof. H.P. Günther from the University of Stuttgart (Report No. 2018-13X). Table 1 shows the results of the detail classification according Eurocode 3, EN 1993-1-9.

Detail category	Constructional detail	Description	Requirements
100* m = 5		<p>New generation Hilti X-BT-GR, X-BT-MR and X-BT-ER power-actuated fasteners with pre-drilled hole in structural steel base material.</p> <p>Imperfect fastener installations as e.g. pulled-out fasteners or pre-drilled holes without fasteners are covered.</p>	<p>$\Delta\sigma$ to be calculated by the gross cross-section.</p> <p>Installation, static loading and spacing of fasteners only in accordance with the requirements given in [1].</p> <p>Plate thickness $t \geq 8$ mm</p> <p>Edge distance ≥ 15 mm</p> <p>When using a fatigue assessment based on a linear damage calculation a mixture of both detail categories is not allowed.</p>
<p>* Alternatively to the propose detail category 100 with m = 5, detail category 90 with m = 3 can be use for $\Delta\sigma \leq 200$ N/mm². Structural steel grades S235 up S960 to EN 10025-2, EN 10025-3, EN 10025-4, EN 10025-6 and EN 10225 are covered. These grades include thermo-mechanically rolled fine grain steels (e.g. S460M) as well as structural high strength steel grades S690 up to S960.</p> <p>[1] Hilti (2018): New Generation Hilti X-BT-GR and X-BT-MR Threaded Fastener Specification. Edition 2018.</p>			

Table 1. Recommendation of fatigue detail category according to EN 1993-1-9:2005, classification by University of Stuttgart, Prof. Kuhlmann and Prof. Günther, Report No. 2018-13X.

Conclusions

- The test results confirm the good-natured behavior known from standard DX powder-actuated fasteners as well as from the previous generation of X-BT threaded fasteners.
- The Eurocode 3 detail category 100 with the slope m = 5 was clearly confirmed for the new generation X-BT threaded studs. This category is equivalent with the classification of the previous generation of X-BT threaded studs.
- The Eurocode 3 detail category 90 with the slope m = 3 can be applied provided the stress ranges $\Delta\sigma \leq 200$ N/mm².
- For typical uses of the X-BT fasteners where fatigue design is essential (e.g. for fastening of equipment in steel towers of wind power plants), the category 100 with m = 5 is in general to be preferred due to load protocols with typically high number of load cycles.

This summary is intended to be representative of the test(s) carried out. It is not intended to be a full and complete test report.

Survey of fatigue test results

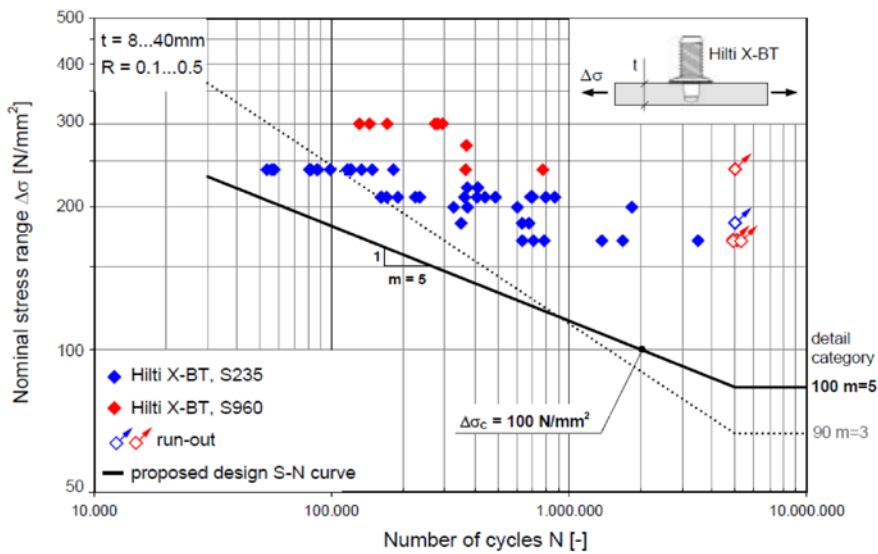

Mathematic description of category 100, m = 5

$$\log N = \log a - m \cdot \log S$$

with:

- log N ... logarithm to base 10 of corresponding cycles of failure N
- log a ... intercept on the log N axis
log a = 16.3 and m = 5
- m ... negative slope of S-N curve being linear on a log-log basis
- log S ... logarithm to base 10 of stress range S ($S = \Delta\sigma$)



This summary is intended to be representative of the test(s) carried out. It is not intended to be a full and complete test report.

5.4.3 Approved fatigue detail categories

Towers for wind turbines, offshore structures or crane constructions often are approved by classification societies like DNV (Det Norske Veritas), LR (Lloyd's Register), ABS (American Bureau of Shipping) and BV (Bureau Veritas). Those classification societies also approved the fatigue category for the constructional detail "Structural steel base material with new generation Hilti X-BT-GR, X-BT-MR and X-BT-ER poweractuated fasteners", see Table 2.

Classification Society	Hilti Type Approval Certificate	Fatigue standard	Detail category
DNV	TAS00001SV	DNVGL-RP-C203	"X-BT" (100, m = 5)
		EC 3, EN 1993-1-9	100, m = 5
LR	19/0003	EC 3, EN 1993-1-9	100, m = 5
ABS	23-2426560-PDA	ABS Offshore Guide	F
		EC 3, EN 1993-1-9	100, m = 5
BV	54054	EC 3, EN 1993-1-9	100, m = 5

Applicable for base material thickness $t \geq 8$ mm and for edge distance ≥ 15 mm

Table 2. Approved fatigue detail categories

Notes on DNV Type Approval:

In addition to the fatigue category 100, m = 5 per EN 1993-1-9, the fatigue category "X-BT" is applicable in connection with DNVGL-RP-C203 (Recommended Practice: Fa-tigue design of offshore steel structures, April 2016). The category "X-BT" represents the product specific fatigue category described in the format of DNVGL-RP-C203 (Table 2-1, S-N curves in air).

The parameters of category "X-BT" are:

- for $N \leq 10^7$ cycles: $m_1 = 5.0$, $\log a_1 = 16.300$
- for $N > 10^7$ cycles: $m_2 = 5.0$, $\log a_2 = 16.300$
- Fatigue limit at 10^7 cycles: 72.4 N/mm^2
- Thickness exponent $k = 0$

Alternatively to the category "X-BT", the detail category D per DNVGL-RP-C203 may be used for $\Delta\sigma \leq 200 \text{ N/mm}^2$.

Structural steel grades: S235 up to S960Q according to EN 10025-2, EN 10025-3, EN 10025-4, EN 10025-6 and EN 10225

Notes on ABS Type Approval:

Class F in air condition (A) per ABS Guide for Fatigue Assessment of Offshore Structures, American Bureau of Shipping, April 2003, updated 2018, applicable for structural steel grades with a nominal yield strength ranging from 235 to 960 N/mm². Classification 100, m = 5 per EN 1993-1-9 applicable for structural steel grades S235 to S460 according to EN 10025-2, EN 10025-3, EN 10025-4 and EN 10225 and for grades S690Q to S960Q according to 10025-6.

Notes on LR Type Approval:

Classification 100, m = 5 per EN 1993-1-9 applicable for structural steel grades S235 to S460 according to EN 10025-2, EN 10025-3, EN 10025-4 and EN 10225 and for grades S690Q to S960Q according to 10025-6.
number of load cycles.

Notes on BV Type Approval:

Classification 100, m = 5 per EN 1993-1-9 applicable for structural steel grades S235 to S460 according to EN 10025-2, EN 10025-3, EN 10025-4 and EN 10225 and for grades S690Q to S960Q according to 10025-6.

Fatigue verification of structural members in ship structures has to be made with the corresponding Bureau Veritas Rules and is subject to specific consideration of Bureau Veritas.

5.5 Technical data for X-BT fastenings made to cast iron with spheroidal graphite

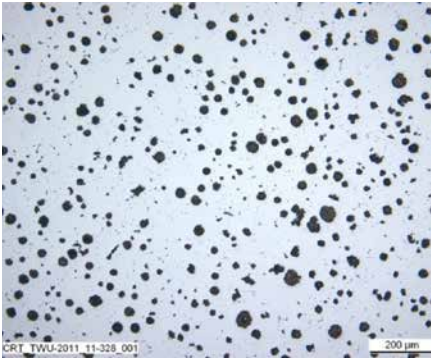

Micro section of cast iron EN-GJS-400-18LT: Spheroidal graphite embedded in ferritic matrix

5.5.1 Cast iron specification

Components made from cast iron with spheroidal graphite are typically used in the nacelle of wind towers. The preferred grade is EN-GJS-400-18-LT according to EN 1563 with a minimum ultimate strength of 400 N/mm², a minimum fracture strain A of 18 % and with impact toughness properties suitable for use in cold temperatures. The use of cast iron with spheroidal graphite allows economical production of complex machinery parts combined with ductile material behavior.

The presence of spherical graphite is required to allow the casting process. The Figure on the left shows a representative example of a micro section of cast iron EN-GJS-400-18-LT. The distribution of the spheroidal graphite in the ferritic matrix is clearly visible.

The cast iron needs to meet the following specification given in the table below. The listed carbon content and microstructure is typical for EN-GJS-400-18-LT used in the nacelle of wind towers.

Subject	Requirements
Cast iron	Spheroidal graphite cast iron according to EN 1563
Strength class	EN-GJS-400 to EN-GJS-600 according to EN 1563
Chemical analysis and amount of carbon	3.3 - 4.0 mass percentage
Microstructure	Form IV to VI (spherical) according to EN ISO 945-1:2010 Minimum size 7 according to Figure 4 of EN ISO 945-1:2010
Material thickness	$t_{II} \geq 20$ mm

Requirements of spheroidal graphite cast iron base material

5.5.2 Grounding and bonding restrictions

No corresponding experimental investigations have been made so far. Therefore, the use of X-BT-ER fasteners for grounding and bonding application is not covered, in case the fasteners are driven to cast iron components.

5.5.3 Performance review

The new generation X-BT threaded fasteners achieves double the performance compared with previous generation of X-BT threaded fasteners.

- Comprehensive experimental investigations with the previous generation of X-BT threaded fasteners were performed to assess their resistance in cast iron (test data see Hilti X-BT Threaded Fastener Specification, July 2015).
- New tension tests clearly confirmed the suitability of the new generation X-BT threaded studs on cast iron. Due to the improved point design the resistances of the new generation X-BT threaded studs are double as high than the values of the previous generation of X-BT threaded studs.

An extract of the fundamental behavior – taken from the “X-BT Threaded Fastener Specification”, July 2015, is repeated as follows:

The scope of the test program performed with the previous generation of X-BT studs included the following experimental investigations.

- Static pullout tests
- Static shear and bending tests
- Tension fatigue tests
- Tests to cover the effect of the edge distance
- Tests to cover the effect of the cast iron surface

Compared with the performance of the previous generation X-BT fasteners in unalloyed structural steel, the recommended load values in cast iron were smaller due to the presence of graphite in the cast iron. As with unalloyed structural steel, reliable anchorage of the X-BT fastener developed also in case of cast iron base material. The anchorage is also caused by predominantly friction welding between the fastener shank and the ferritic or perlitic matrix of the cast iron. However, the presence of the graphite reduces the effective contact area, which explains the reduction of the pullout strength.

Furthermore, the recommended loads implicitly cover effects of dynamic and variable loading on the fastener. This statement is based on the results of tension fatigue tests, which were performed to investigate the robustness of the anchorage of X-BT fasteners in cast iron.



Servo-hydraulic test setup for tension fatigue tests

This summary is intended to be representative of the test(s) carried out. It is not intended to be a full and complete test report.

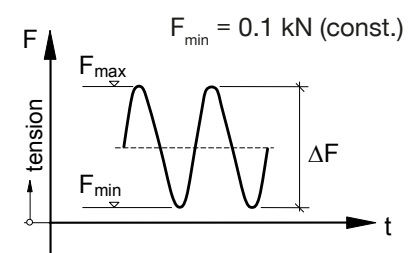
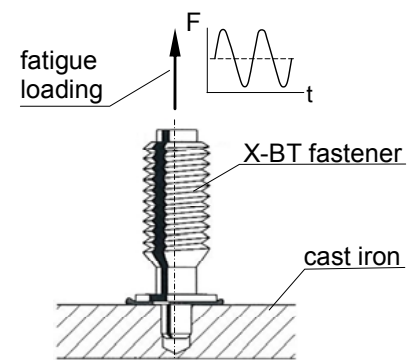

Principle sketch of cyclic tension tests

Conclusions from the cyclic tension tests:

- The anchorage of the X-BT does not work loose. In none of the tests pull-out of the fastener from the cast iron was the controlling mode of failure.
- Failure was controlled by fatigue fracture of the stainless stud material. The fractures occurred at upper loads significantly beyond the recommended tension load (0.5 kN for the previous generation, 1.0 kN for new generation X-BT fastener).
- For final verification and with respect to the reported design life of wind towers, two fatigue tests were performed with an upper load of 1.0 kN and a target number of 200 million load cycles.
- Both “long run” samples passed the test without any damage, neither lead to fracture of the stud material nor to failure of the anchorage. Residual static pullout tests of these two samples (from the previous generation of X-BT studs) resulted in a pullout strength beyond 5 kN.
- These test results clearly verified reliable X-BT fastenings to cast iron EN-GJS-400-18LT used in the nacelle of wind towers.

Figure 4 shows a graph of the fatigue test results performed with the X-BT fasteners. The load-level of the runouts (at 10 Mio load cycles) is by far beyond the recommended working load of 0.5 kN of the previous and 1.0 kN of the new generation X-BT threaded fastener, especially see the two run-outs at 200 million load cycles with an upper load of 1.0 kN.

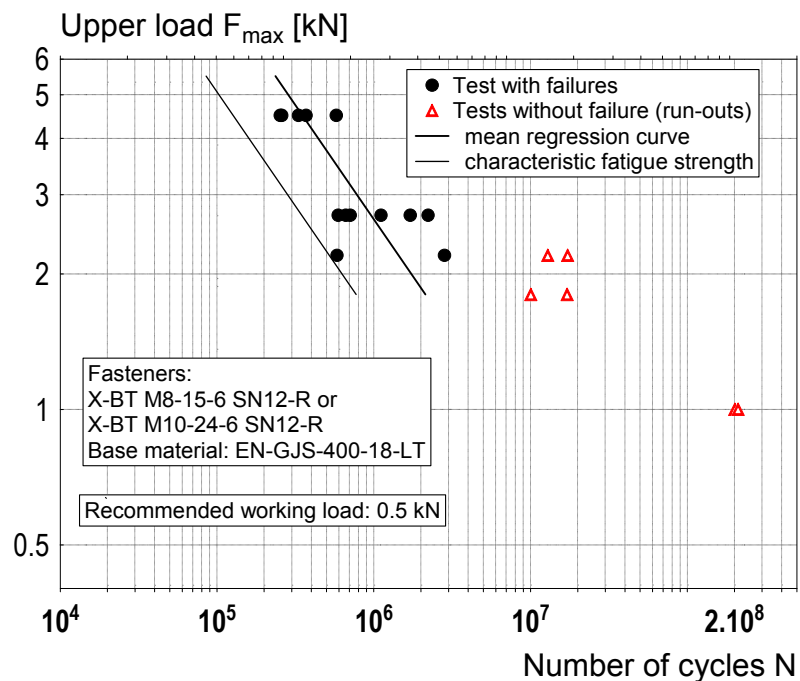

Results of cyclic tension tests

Literature:

Kuhlmann, U., Günther, H-P. (2011): Hilti powder-actuated fastener X-BT in combination with the Hilti fastening tools DX 351 BT/BTG for the use in cast iron base material according to EN 1563, Evaluation Report, Institut für Konstruktion und Entwurf, Stahl- Holz- und Verbundbau, University of Stuttgart, Report Nr. 2011-24X, Oct. 11, 2011.

This summary is intended to be representative of the test(s) carried out. It is not intended to be a full and complete test report.

5.6 Vibration effects on X-BT threaded stud fastenings

The anchorage of the new generation X-BT threaded fasteners is robust related to dynamic base material stress (vibration) as well as related to dynamic loading of the stud itself.

Due to the similar friction welding anchorage mechanism, the general conclusions drawn from the base material vibration tests performed with the previous generation of X-BT threaded fasteners apply also for the new generation X-BT threaded fasteners.

Therefore, those tests performed with the previous generation of X-BT fasteners are summarized below. The sections are taken from the “X-BT Threaded Fastener Specification”, July 2015:

Experimental investigations on the effect of base metal vibrations on the ultimate pull-out strength

Report No. XE-02-09, Beck H., 19 June 2002

Base material	Steel, S235
Beam section	HE-A section, 9 mm flange, 6 mm web
Test procedure:	Beam loaded in the center $F_{max} = 155 \text{ kN}$, $F_{min} = 33 \text{ kN}$ Frequency = 6 Hz Number of cycles = 2 Million
Number of fastenings:	210 X-BT fasteners, some with X-FCM-R grating disks

Tension pull-out loads of X-BT fasteners before and after cyclic loading of the steel beam

X-BT fasteners in area without grating

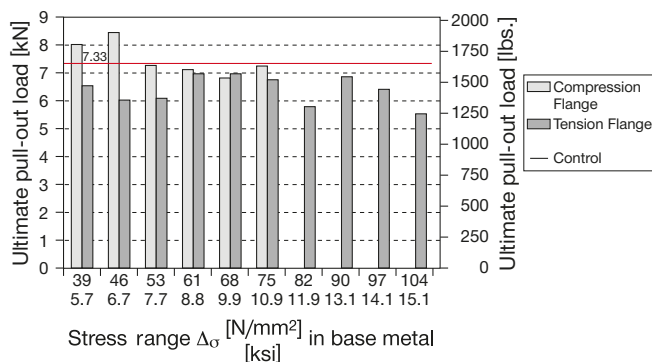

X-BT fasteners in area with grating

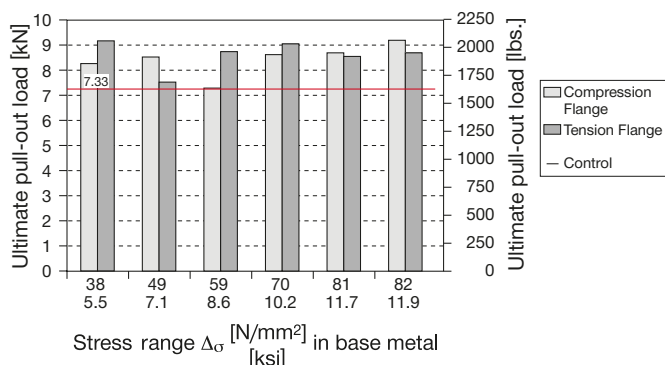

This summary is intended to be representative of the test(s) carried out. It is not intended to be a full and complete test report.

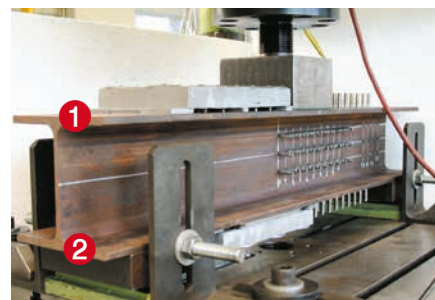

1 Compression flange
2 Tension flange



3 Markings to measure disc rotation

Notes:

- 7.33 kN = Ultimate pull-out load of the sample before stress was applied (control).
- No measurements taken on the compression flange in the high stress area due to position of the press.

Conclusions

- Cyclic loading applied to steel beams, which causes vibration on the fastener, has only a negligible effect on the ultimate pull-out of X-BT threaded studs
- Cyclic loading applied to steel beams, which causes vibration on the fastener, does not result in loosening of grating X-FCM-R grating disks



Dynamic tension loading on the new generation X-BT threaded fastener demonstrates excellent robustness of anchorage.

Evaluation report on new generation Hilti X-BT-GR, X-BT-MR and X-BT-ER threaded fasteners,

Hilti Report XE-18-12, Beck H., 2018-05-22

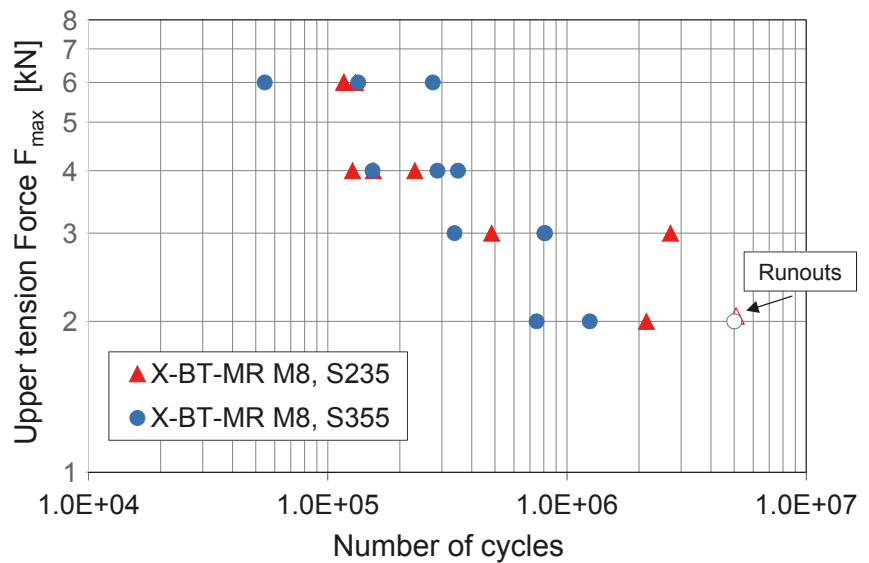
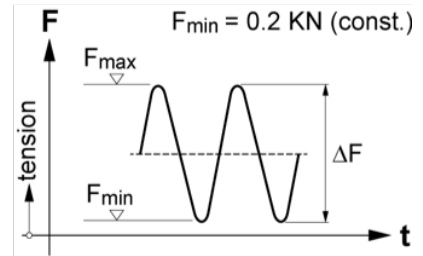
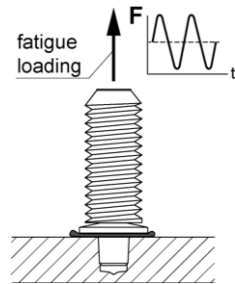

Conclusions

- The anchorage does not work loose due to dynamic loading. Fatigue fracture of the stud material itself controls the fatigue life of the connection.
- Quasi-static design applying the recommended tension load values is conservatively and clearly covered.

Note

In case fatigue design of the new generation X-BT is required, inquire at Hilti.

This summary is intended to be representative of the test(s) carried out. It is not intended to be a full and complete test report.

5.7 Temperature resistance of X-BT threaded stud fastenings

Evaluation report on new generation Hilti X-BT-GR, X-BT-MR and X-BT-ER threaded fasteners,

Hilti Report XE-18-12, Beck H., 2018-05-22

The temperature resistance of the Hilti X-BT fastening system is affected by

- the temperature resistance of the stud itself
- the resistance of the X-BT stud anchorage in steel base material
- the temperature resistance of the SN sealing washer
- the effect of temperature on the corrosion resistance of the stud

Temperature resistance of the new X-BT stud and its anchorage in carbon steel

Base material steel: Thickness 10 mm, Grade S235 (Rm = 367 MPa)

Tested temperature: 20 °C and elevated temperatures 200 °C, 400 °C, 600 °C (10 samples per temperature) and -50 °C with 5 samples

Pull-out test configuration

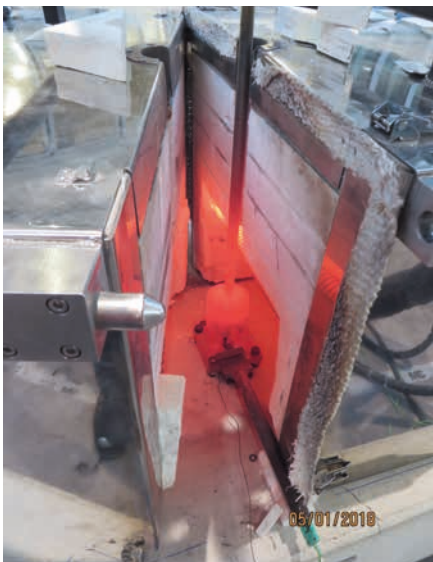

The chamber is heated as long, till the test temperature of the steel base material is reached. The right photo shows the temperature sensor ("black wire") which is fixed in the base material in a small bore hole of 2 mm diameter close to the X-BT threaded fastener. If the target temperature in the base steel is reached, the tension pull-out test is performed (with closed chamber). The photos show the opened chamber after the tension test was executed.

The samples for the cold temperature tests were prepared in a separate cooling chamber.

This summary is intended to be representative of the test(s) carried out. It is not intended to be a full and complete test report.

Results

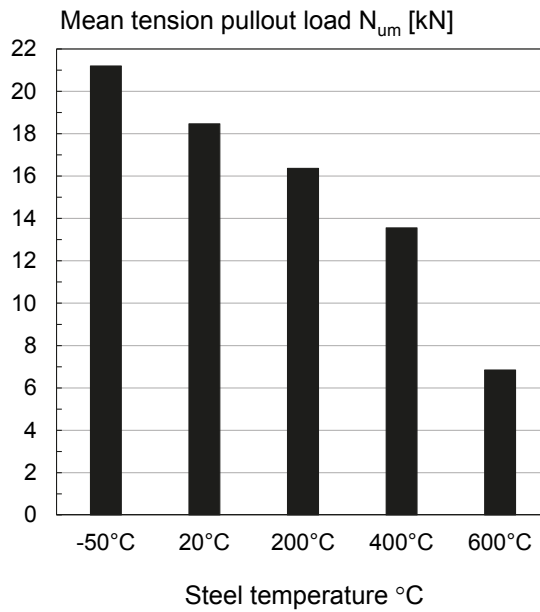

Conclusions

- Pull-out of the stud from the carbon steel was the controlling mode in all cases. The reduction of the tension pull-out resistance follows approximately the effect of temperature on the strength of construction steel. This observation is in well agreement with the friction welding anchorage mechanism.
- In all test series the scatter is very small with a maximum COV of 6.2% at 600 °C.
- If the fastener is used on fire protected steel structures (with steel temperature typically less than 600 °C in case of a fire), the full utilization of the recommended service loads will often be possible. The respective specific safety margins in case of a fire need to be observed.

Statements on service temperature:

The recommended service temperature in marine atmospheres amounts between -40 °C to +60 °C. The use up to 100 °C ambient temperature is possible when the specific environmental conditions for these cases are taken into account. Those limits are determined by the sealing function of the rubber material of the sealing washer of the X-BT threaded fastener.

Note on corrosion resistance:

The corrosion resistance of stainless steel material, such as the duplex steel 1.4462 of the new generation X-BT threaded fasteners, is also affected by temperatures beyond 300 °C. However, as the maximum service temperature is determined by 100 °C concerning the sealing washer, the limit of 300 °C related with the durability of the stainless material is in general not relevant.

5.8 X-BT-ER stainless steel threaded studs electrical performance

5.8.1 Survey of tests and reference to separate X-BT-ER data sheet

In 2022 and 2023 a representative set of X-BT-ER studs were tested in combination with adapters at the DEHN Test centre in Germany following the relevant current test standards. The results are presented in a separate X-BT-ER product data sheet (X-BT-ER – Stainless steel threaded stud for electrical connection) provided as part of the Hilti Direct Fastening Technology Manual.

Type of testing, test procedures and the respective test reports are summarized as follows.

Stud and adapter	Test	Test procedure	Test report
X-BT-ER M8/7 SN 8 with adapter M8-MR 100	Short-time current and temperature rise test	IEC 60947-7-1:2009 IEC 60947-7-2:2009	Dehn Test Centre No. 2277_FRM
	Lightning impulse current (Class N)	IEC 62561-1:2017-03 (Edition 2.0)	Dehn Test Centre No. 2280_FRM
X-BT-ER M10/7 SN 8 with adapter M10 HC 120	Short-time current and temperature rise test	IEC 60947-7-1:2009 IEC 60947-7-2:2009	Dehn Test Centre No. 2332_FRM
	Lightning impulse current (Class H)	IEC 62561-1:2017-03 (Edition 2.0)	Dehn Test Centre No. 2342_FRM

With respect to more detailed information it is referred to these procedures and reports.

These new test results complement former tests results summarized in the previous “New Generation Hilti X-BT-GR, X-BT-MR and X-BT-ER Threaded Fastener Specification” from July 2019.

5.8.2 Effect of X-BT-ER fasteners on integrity of pipe flanges

Installation of a Hilti X-BT(-ER) threaded stud is not expected to have negative influence on the integrity of flanged pipe joints made from typical ductile steel materials, when installed in the outer area of the pipe flange between 2 tension bolts.

Hilti’s recommendations for edge distance, spacing, minimum flange diameter and minimum base material thickness, as well as Hilti’s printed literature, must be considered during design and installation.

- Outer diameter of pipe flange \geq 150 mm (6 inches).
- Minimum edge distance = 6 mm
- Minimum pipe flange thickness = 12 mm.
- X-BT-ER installed on center of pipe flange and between 2 tension bolts.

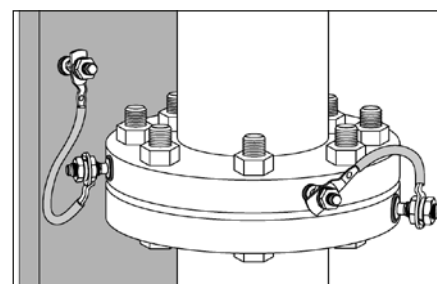

Functional and protective bonding of pipes.

5.9 X-BT in stainless steel base material

The same aspects are to be considered for the new generation X-BT threaded fasteners as for the previous generation of X-BT threaded fasteners.

Therefore, the following recommendations summarizing the use of X-BT in stainless steel taken from the “X-BT Threaded Fastener Specification”, July 2015, also apply for the new generation X-BT threaded fasteners (together with the respective new drill TX-BT 4.7/7).

Report:

Hilti internal report XE-07-26; Buhri R., 2007-05-21

Stainless steel is very hard, so the drilling technique differs from that used for structural steel, the material for which the X-BT system has been optimized.

Driving the X-BT stud in stainless steel presents no problem, but drilling is decisive.

Test material and conditions

Type of drill bit:	Standard TX-BT 4/7 step shank drill bit Two special shank drill bits for stainless steel
Type of stainless steel material:	Material number: 1.4401, 1.4404, 1.4462, 1.4529, 1.4539
Drilling procedure:	Wet or dry
Number of tests:	495 drilling operations with 28 drill bits
Condition:	Hand held operation, same as the standard operation

Results

- With all of the stainless steel materials tested, the standard TX-BT 4/7 drill bit was found to perform better than special drill bits.
- Cooling the drill bit does not lead to better results.
- Use of a corded electric drill is recommended due to the longer drilling time.
- Best results are achieved with a corded drill set to a speed of 1000 r.p.m.
- To achieve satisfactory drilling performance, much higher pressure must be applied to the drill bit.
- About 25 to 35 holes can be drilled with a TX-BT 4/7 drill bit.
- Characteristic pull-out loads are in the 8 to 16 kN range, which provides an adequate safety factor for the recommended loads. (Note: Results refer to previous generation of X-BT threaded fasteners)

Recommendation

For making fastenings in stainless steel with new generation Hilti X-BT studs, we recommend use of the standard TX-BT 4.7/7 drill bit with a drill tool having a speed close to 1000 r.p.m.

Examples of suitable Hilti models:

- UD 30 – set at gear 1 @ 1200 r.p.m
- UH 700 – set at gear 1 @ 900 r.p.m
- SF 10W-A22 ATC – set at gear 3 @ 1210 r.p.m (cordless tool)

This summary is intended to be representative of the test(s) carried out. It is not intended to be a full and complete test report.

5.10 X-BT under shock loading

Due to the similarity in the anchorage mechanism, the same shock behavior is expected for the new generation X-BT threaded fasteners as for the previous generation of X-BT threaded fasteners.

Therefore, the test information on shock tests performed with the previous generation of X-BT threaded fasteners, taken from the “X-BT Threaded Fastener Specification”, July 2015, is reported as follows:

Shock tests with X-BT studs and MQ channel systems fastening electrical cable and pipe runs are described in these documents:

- Test certificate number QUINETIQ/CMS/TC040089
- QinetiQ Shock Test Laboratory, 15.01.2004
- Report 2004-CMC-R017, TNO Delft, Netherlands, 29.05.2005

Mechanical and electrical equipment fastened with MQ channels and X-BT studs tested under shock load.

- Small-bore pipe runs
- High-voltage cable runs
- T-bars for fastening high-voltage cables
- Cable basket electrical runs
- Cable tray electrical runs

All applications were tested with an effective acceleration of 1844 m/s^2 in the three orthogonal axes, in horizontal (longitudinal and side to side) and vertical direction. In another test, X-BT studs with a mass of 3 kg each were installed on a shock test rig and tested with a maximum effective acceleration of 4905 m/s^2 .

Test results

- The channel system, the X-BT studs and the attached equipment remained captive at all times.
- The tested effective acceleration of 1844 m/s^2 corresponds to a shock load of 188 G.
- The X-BT with a fastened mass of 3 kg withstood a shock load of 200 G in horizontal (shear) and 500 G in longitudinal (tension) direction.

Lightweight high impact shock testing of Hilti X-BT studs for electrical cable holder, electrical box and slotted channel installations are also described in HI-TEST LABORATORIES, INC., Report No. 1475, April 30, 2007. X-BT stud fastened assemblies were subjected to lightweight high impact shock tests in accordance with MIL-S-901D (NAVY) and HI-TEST Procedure No. HT-1780-TP-1, Revision “-”.

Testing was conducted at HI-TEST LABORATORIES, INC., Arvon, Virginia, using their standard Navy shock testing machine for lightweight equipment. HI-TEST LABORATORIES, INC. is approved for class H.I. (High Impact) shock testing by NAVSEA per NAVSEAINST 9491.1C dated 21 March 1996. Nine blows were applied to each test item - three blows in each of the three mutually perpendicular axes of the test item (from the top, back, and side) at hammer heights of 1, 3, and 5 feet. Two separate lightweight shock tests were performed, one for each test panel. Shock test accelerations ranged from 80 to 300 G's.

Test Results

There was no evidence of broken or loose parts during the test series. There was also no evidence of damage to the test cables that could be considered an electrical hazard.



Test configuration: Two base plates were populated with MQ channel fastened with X-BT studs. The base plates were rigidly attached to the 2-tonne shock loading machine.

This summary is intended to be representative of the test(s) carried out. It is not intended to be a full and complete test report.

5.11 X-BT stud in steel with a thickness of less than 8 mm

5.11.1 Pull-out capacity in thin steel

Evaluation report on new generation Hilti X-BT-GR, X-BT-MR and X-BT-ER threaded fasteners,

Hilti Report XE-18-12, Beck H., 2018-05-22

The characteristic pull-out resistance of new generation X-BT threaded studs reduces with base material thickness. Below 8 mm base material through penetration of the base material is possible. The minimum base material thickness amounts to 4 mm. Test data confirmed that the same linear reduction with the factor α – as for the previous generation X-BT threaded fasteners – results in a conservative prediction of the tension resistance.

Reduction factor: $\alpha = \frac{t_{II} - 2}{6}$

with t_{II} = thickness of base steel, $4 \text{ mm} \leq t_{II} \leq 8 \text{ mm}$

Example: For a base steel thickness of 6 mm, the recommended loads using global safety factors are:

Steel S235 / ASTM A36: $N_{\text{rec},6} = 3.6 \cdot (6-2)/6 = \mathbf{2.40 \text{ kN}}$

Steel S355 / Grade 50: $N_{\text{rec},6} = 4.6 \cdot (6-2)/6 = \mathbf{3.05 \text{ kN}}$

Recommended tightening torque T_{rec}

- For base material thickness $6 \leq t_{II} < 8 \text{ mm}$, the tightening torque $T_{\text{rec}} \leq 20 \text{ Nm}$ is recommended (such as for base material thickness $t_{II} \geq 8 \text{ mm}$).
- For base material thickness $4 \leq t_{II} < 6 \text{ mm}$, the tightening torque $T_{\text{rec}} \leq 8 \text{ Nm}$ is recommended.

5.11.2 Shear load capacity in thin steel

Tension and shear tests with Hilti stud X-BT-GR M8/7 SN 8

Report 254/17, HTL-Rankweil (2017), Wechner W., 2017-12-04

Test results performed in 6 mm base material resulted to high shear resistances very similar with the performance in 8 mm thick base material. Conservatively, the same reduction factors α as for tension loads are recommended to be used.

General note

With a base steel thickness of less than 8 mm, it can no longer be ensured that corrosion protection on the reverse side of the steel plate remains intact.

5.12 X-BT on structural steel with passive fire protection (PFP) coating

5.12.1 Introduction

Structural steel with passive fire protection (PFP) coatings are often encountered in onshore and offshore facilities, e.g. for load-bearing structures supporting tanks, pipelines and electrical equipment. Herein, the PFP seeks to slow down fire propagation and extend the structural integrity of the coated members.

There are 2 main types of PFP coating: Intumescent and Cementitious. Intumescent coatings are commonly used in on- and offshore applications due to their advantages in terms of ease of installation and performance. These epoxy-based coatings come in a thickness range ≤ 20 mm [0.78"] either mesh free or with a carbon fiber mesh. When exposed to fire their volume expands creating a thermo-insulating barrier.

Cementitious coatings are generally based on Portland cement and lightweight aggregates, protecting steel via high mass (coating thickness) and low thermal conductivity. Cementitious coatings are typically installed with a steel mesh and with an application thickness ranging from 10 mm [0.39"] to 70 mm [2.76"]. They have no significant expansion property when exposed to fire.

The proposed fastening method uses direct fastening solution together with standoff adapters as an alternative to welding and boxing methods of attachment to PFP-coated structural steel. The local PFP-coating removal is done with a special drill bit. Then the X-BT fastener is installed allowing a standoff adapter to be screwed on, therefore allowing a fastening point above the coating.

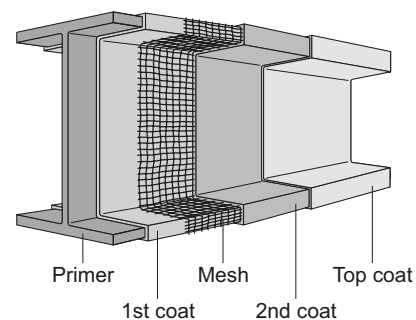

Passive fire protection (PFP) coating in steel construction

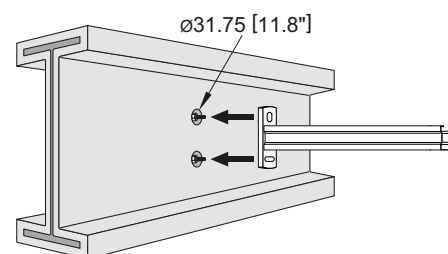

Fastening with X-BT and standoff adapter

5.12.2 Features and benefits

Simple and fast:

The method proposed utilizes mechanical fasteners and battery tools. Minimal training is required for a user to be able to install up to 25 fastening points per hour.

Reduced influence on integrity of fireproofing

Per fastening point only 791 mm² [1.23 sqin] of PFP-coating is removed with a heat conducting cross-section of 16 mm² [0.03 sqin]. Additionally, in the case of less than four fastening points per meter length or per square meter of surface area, the integrity of the PFP-coating may not be compromised (Steel Construction Institute (SCI), Fire Loading and Structural Response, FABIG Technical Note 11, 2009). Please verify with your local regulations and PFP-coating supplier.

High corrosion resistance:

The stainless steel standoff adapters are made from the austenitic stainless steel type 1.4401, AISI 316 (A4) grade and suitable for aggressive environments like in coastal and offshore applications.

The coating of the carbon steel standoff adapters consists of an electroplated Zn-alloy for cathodic protection and a top coat for chemical resistance (Duplex-coating). The use of this coating is limited to indoor environments and outdoor (non-coastal) environments with low pollution.

Cordless and Portable:

The cordless drilling and installation tools eliminate the need for electrical cords and heavy welding equipment.

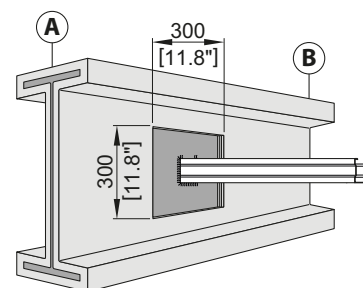

Welding method (front)

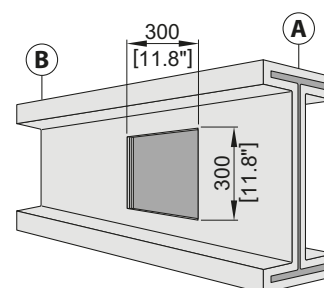

Welding method (back)

5.12.3 Fastener program

System component	Item no.	Designation	Image	
Threaded stud	2194344	X-BT-GR M8/7 SN 8		
	2194340	X-BT-MR M10/15 SN 8, incl. flange nut		
	2194341	X-BT-MR W10/15 SN 8, incl. flange nut		
Standoff adapter	2268522	Adapter M8-MR25, incl. wide M8 flange nut		
	2268523	Adapter M8-MR50, incl. wide M8 flange nut		
	2268524	Adapter M8-MR75, incl. wide M8 flange nut		
	2268525	Adapter M8-MR100, incl. wide M8 flange nut		
	2281193	Adapter M10-MR50		
	2394867	Adapter M10-MR 75		
	2394868	Adapter M10-MR 100		
	2281191	Adapter W10-MR50		
	2394869	Adapter W10-MR 75		
	2395330	Adapter W10-MR 100		
	2268526	Adapter M8-MF 25, incl. wide M8 flange nut		
	2268527	Adapter M8-MF 50, incl. wide M8 flange nut		
	2268528	Adapter M8-MF 75, incl. wide M8 flange nut		
	2268529	Adapter M8-MF 100, incl. wide M8 flange nut		
	2281194	Adapter M10-MF 50		
2281192	Adapter W10-MF 50			
Drill bit	2394866	TX-BT 31-95 PFP		
Tool	2194595	BX3-BT		
	2194592	BX3-BTG		
	377613	DX351 BT		
	377616	DX351 BTG		
	2123719	SFBT22-A		
	2119272	Torque tool X-BT 1/4" - 8 Nm		
	2212510	Torque tool X-BT 1/4" - 20 Nm		
Nutsetter	2149244	S-NS 13 C95/3 3/4"		
	2149245	S-NS 15 C95/3 3/4"		
	2149246	S-NS 9/16" C95/3 3/4"		
	2268521	S-NS 3/4" 95/3 3/4"		
Bored plate	304071	Bored Plate MQZ-L9-R		
	304196	Bored Plate MQZ-L9-F		
	304072	Bored Plate MQZ-L11-R		
	304197	Bored Plate MQZ-L11-F		

5.12.4 Fastener and standoff adapter combinations

Fastener	Standoff adapter	Material	Standoff length
X-BT-GR M8/7 SN8	Adapter M8-MR 25	Stainless steel	25 mm [1"]
	Adapter M8-MR 50	Stainless steel	50 mm [2"]
	Adapter M8-MR 75	Stainless steel	75 mm [3"]
	Adapter M8-MR 100	Stainless steel	100 mm [4"]
	Adapter M8-MF 25	Carbon steel	25 mm [1"]
	Adapter M8-MF 50	Carbon steel	50 mm [2"]
	Adapter M8-MF 75	Carbon steel	75 mm [3"]
X-BT-MR M10/15 SN8	Adapter M10-MR 50	Stainless steel	50 mm [2"]
	Adapter M10-MR 75	Stainless steel	75 mm [3"]
	Adapter M10-MR 100	Stainless steel	100 mm [4"]
	Adapter M10-MF 50	Carbon steel	50 mm [2"]
X-BT-MR W10/15 SN8	Adapter W10-MR 50	Stainless steel	50 mm [2"]
	Adapter W10-MR 75	Stainless steel	75 mm [3"]
	Adapter W10-MR 100	Stainless steel	100 mm [4"]
	Adapter W10-MF 50	Carbon steel	50 mm [2"]

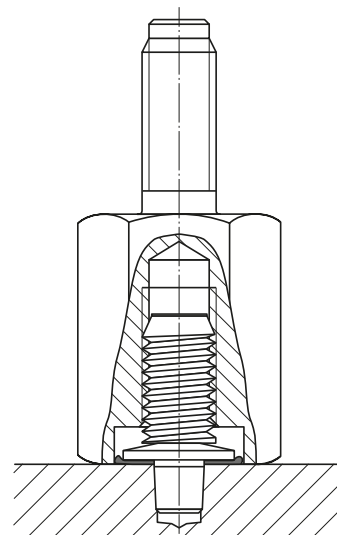

The stainless standoff adapters M8-MR 50, M8-MR 75, M8-MR 100, M10-MR 50, M10-MR 75, M10-MR 100, W10-MR 50, W10-MR 75 and W10-MR 100 may also be used in combination with X-BT-ER fasteners for electrical applications.

HC "High Current" standoff adapters M10-HC120 50, W10-HC120 50, M10-HC120 100 and W10-HC120 100 made of a copper tin alloy are additionally available. These are only used for electrical applications in combination with the X-BT-ER fasteners. Information on these adapters and their performances are also given in the separate X-BT-ER product data sheet (X-BT-ER – Stainless steel threaded stud for electrical connection) provided as part of the Hilti Direct Fastening Technology Manual.

5.12.5 Installation information

Fastening standoff adapter with X-BT on PFP-coated steel

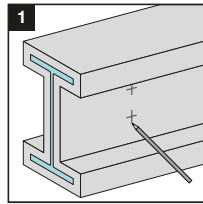

1
Mark location of each fastening.

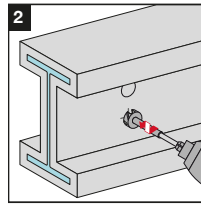

2
Remove PFP and pre-drill with stepped drill bit TX-BT 31-95 PFP ...

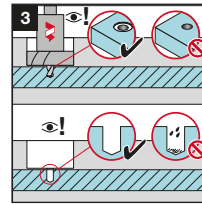

3
... until shoulder grinds a shiny ring. The drilled hole and the area around drilled hole must be clean and free from liquids and debris.

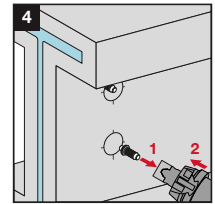

4
Set studs into drilled hole with direct fastening tool.

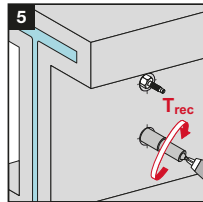

5
Screw-on the Hilti standoff adapter on the stud and tighten it with the recommended installation torque T_{rec} of 8 Nm.

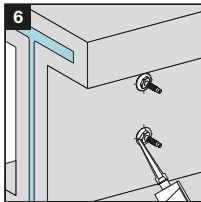

6
Close the opening within 4 hours. The opening is being closed in accordance with the patching instructions by the PFP-manufacturer.

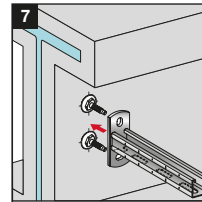

7
Position accessory on standoff adapter and hold in place. Use of MQZ bore plate as needed for strut applications.

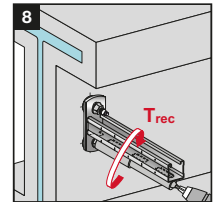

8
Fasten the accessory on the standoff adapter with the recommended installation torque T_{rec} of 20 Nm.

Important notes:

These are abbreviated instructions which may vary by application.

ALWAYS review/follow the instructions for use (IFU) accompanying the product.

Grating fastening with standoff adapter with X-BT on PFP-coated steel

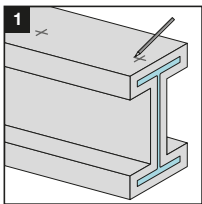

1 Mark location of each fastening.

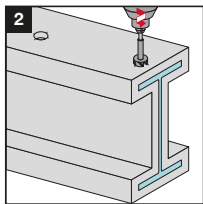

2 Remove PFP and pre-drill with stepped drill bit TX-BT 31-95 PFP ...

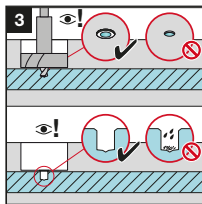

3 ...until shoulder grinds a shiny ring. The drilled hole and the area around drilled hole must be clean and free from liquids and debris.

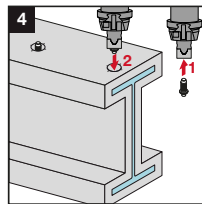

4 Set studs into drilled hole with direct fastening tool.

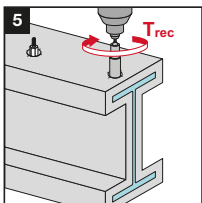

5 Screw-on the Hilti standoff adapter on the stud and tighten it with the recommended installation torque T_{rec} of 8 Nm.

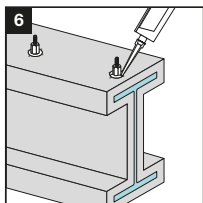

6 Close the opening within 4 hours. The opening is being closed in accordance to the patching instructions by the PFP-manufacturer.

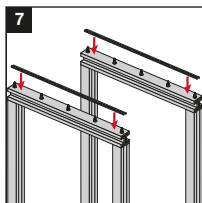

7 Position Oglænd channel CH50-1 on standoff adapter. If a Oglænd channel CH50-1 is used, a stainless steel washer is required between the standoff adapter and the channel to prevent deformation of the channel when the X-FCM disc is tightened.

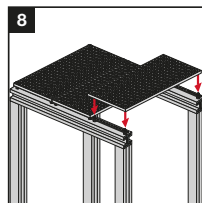

8 Position grating on top of the Oglænd channel S-M CH50-1 and standoff adapter and hold in place.

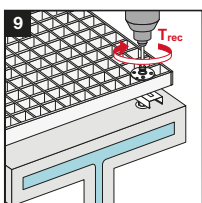

9 Tighten X-FCM discs with 5 mm Allen-type bit with the suited installation torque.

Important notes:

These are abbreviated instructions which may vary by application. ALWAYS review/follow the instructions for use (IFU) accompanying the product.

Electrical connections with standoff adapter made of stainless steel with X-BT-ER on PFP-coated steel

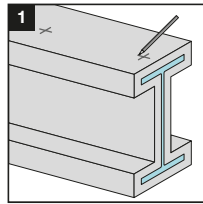

1
Mark location of each fastening.

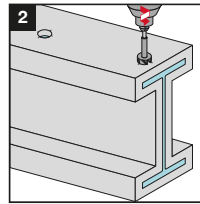

2
Remove PFP and pre-drill with stepped drill bit TX-BT 31-95 PFP ...

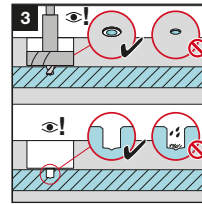

3
... until shoulder grinds a shiny ring. The drilled hole and the area around drilled hole must be clean and free from liquids and debris.

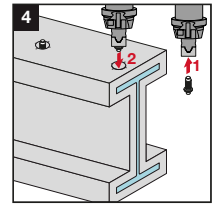

4
Set X BT-ER electrical connectors into drilled hole with direct fastening tool.

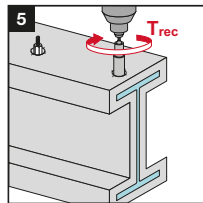

5
Screw-on the Hilti standoff adapter on the stud and tighten it with the recommended installation torque T_{rec} of 8 Nm.

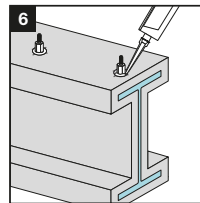

6
Close the opening within 4 hours. The opening is being closed in accordance with the patching instructions by the PFP-manufacturer.

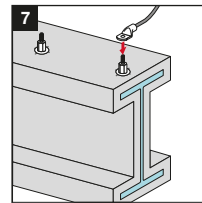

7
Position cable lug on standoff adapter and hold in place.

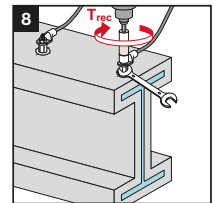

8
Add the spring washer and tighten the nut with the recommended installation torque T_{rec} of 16 Nm.

Important notes:

These are abbreviated instructions which may vary by application. ALWAYS review/follow the instructions for use (IFU) accompanying the product.

Fastening standoff adapter with X-BT on bare steel members

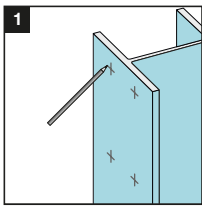

1
Mark location of each fastening.

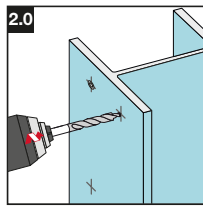

2.0
Pre-drill with stepped drill bit TX-BT 4.7/7 ...

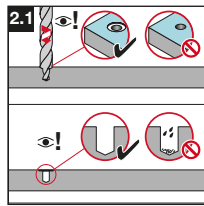

2.1
...until shoulder grinds a shiny ring. The drilled hole and the area around drilled hole must be clean and free from liquids and debris.

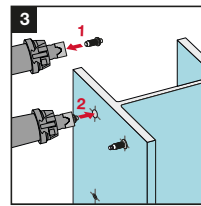

3
Set studs into drilled hole with direct fastening tool.

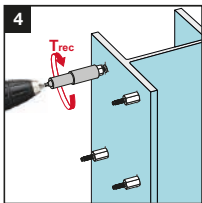

4
Screw-on the Hilti standoff adapter on the stud and tighten it with the recommended installation torque T_{rec} of 8 Nm.

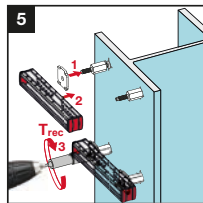

5
Position channel on standoff adapter and hold in place. Tighten the nuts with a tightening torque T_{rec} of 20 Nm.

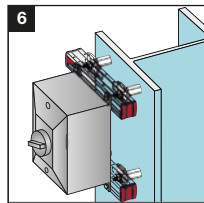

6
Fasten the accessory on the channel with the suited installation torque.

Important notes:

These are abbreviated instructions which may vary by application. ALWAYS review/follow the instructions for use (IFU) accompanying the product. In case of a drill through hole, rework of the coating on the back side of the plate/profile may be needed.

5.12.6 Standoff adapter material specifications and dimensions

	Stainless steel MR	Carbon steel MF
Adapter	① Stainless steel (X5CrNiMo17-12-2) 1.4401-AISI 316	② Carbon steel (11SMnPb37+C) duplex-coated
Flange nut	⑤ Stainless steel grade A4 – 70/80	⑥ Carbon steel HDG, grade 8
Adapter M 8-MR 25 Adapter M 8-MR 50 Adapter M 8-MR 75 Adapter M 8-MR 100 Adapter M 8-MF 25 Adapter M 8-MF 50 Adapter M 8-MF 75 Adapter M 8-MF 100		
Adapter M 10-MR 50 Adapter M 10-MR 75 Adapter M 10-MR 100 Adapter M 10-MF 50 Adapter W 10-MR 50 Adapter W 10-MR 75 Adapter W 10-MR 100 Adapter W 10-MF 50		
Flange nut		

5.12.7 Corrosion information

The stainless steel standoff adapters are made from the stainless steel type 1.4401 (AISI 316). This grade of stainless steel is classified as corrosion resistance class III according to DIN EN 1993-1-4:2015, which makes the material suitable for outdoor applications and atmospheres containing chloride ions, i.e. coastal areas and areas near roads treated with de-icing salts.

The coating of the carbon steel standoff adapters consists of an electroplated Zn-alloy for cathodic protection and a top coat for chemical resistance (Duplex-coating). The use of this coating is limited to the corrosivity category C1, C2 and C3 according to the standard EN ISO 9223. For higher corrosivity categories stainless steel standoff adapters should be used.

5.12.8 Load data with standoff adapter

Recommended resistance under tension load, shear load and torque moment

Resistance under tension, shear load and torque moment	Standoff adapter	Steel grade	
		S 235, S 275, A 36	S 355 to S 960 ≥ Grade 50
N_{rec}	25, 50, 75, 100 mm	3.60 kN/810 lb	4.60 kN/1035 lb
V_{rec}	25 mm	1.14 kN/255 lb	1.43 kN/320 lb
	50 mm	0.62 kN/140 lb	0.78 kN/175 lb
	75 mm	0.52 kN/115 lb	0.65 kN/145 lb
	100 mm	0.35 kN/80 lb	0.44 kN/100 lb

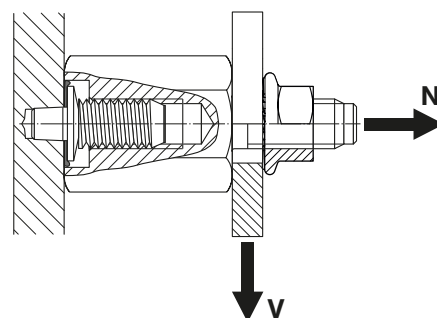

Design resistance under tension load and shear load

Resistance under tension and shear load	Standoff adapter	Steel grade	
		S 235, S 275, A 36	S 355 to S 960 ≥ Grade 50
N_{Rd}	25, 50, 75, 100 mm	5.00 kN/1120 lb	6.50 kN/1460 lb
V_{Rd}	25 mm	1.60 kN/360 lb	2.00 kN/450 lb
	50 mm	0.87 kN/195 lb	1.09 kN/245 lb
	75 mm	0.73 kN/165 lb	0.91 kN/205 lb
	100 mm	0.49 kN/110 lb	0.61 kN/135 lb

Condition:

- Use X-BT-MR and X-BT-GR only with the Hilti standoff adapter M 8-MF/R, M 10-MF/R.
- For unalloyed construction, off-shore and Shipbuilding steel: e.g. European grades according to EN 10025-4 or EN 10225, S690Q and S960Q according to EN 10025-6, US steel grade A36 and Grade 50.
- Minimum base material thickness $t_{II} = 8$ mm.
- Edge distance $c \geq 10$ mm [3/8"].
- Applicable for steel base materials up to a remaining coating thickness after PFP-removal of 500 μ m.
- Maximum displacement in shear load direction ≤ 2.0 mm [0.08"].
- Redundancy (multiple fastening) must be provided.

Working load design concept:

- Global safety factor for tension and shear load = 2.8 related to the characteristic resistance N_{Rk} and V_{Rk} .

Partial safety factor concept:

- Design loads can be used for the design according the partial safety concept, e.g. EN 1993-1-1 (Eurocode 3).
- Design resistances N_{Rd} and V_{Rd} are determined from the characteristic resistance N_{Rk} and V_{Rk} applying a partial safety factor $\gamma_M = 2.0$.

5.12.9 Method statement – Instruction for use



**TX-BT 31-95 PFP
Removal Drill Bit X-BT**

2398300-07.2023



Hilti Corrosion handbook / DFTM

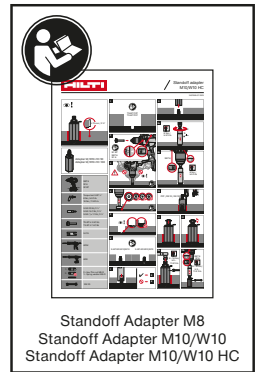
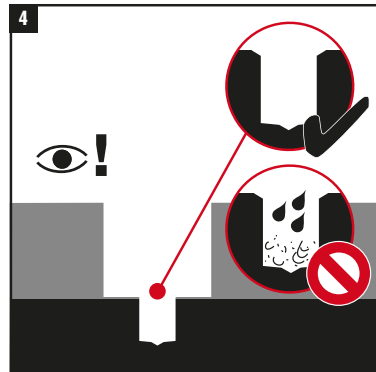
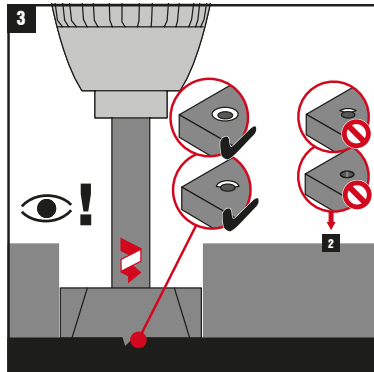
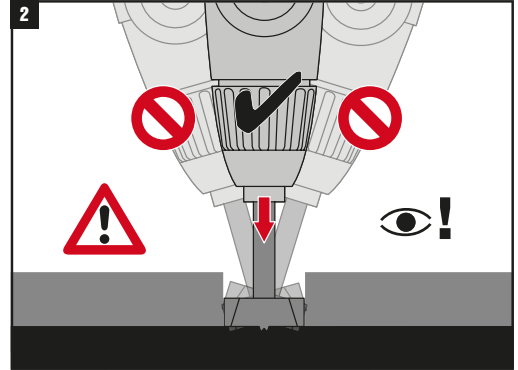
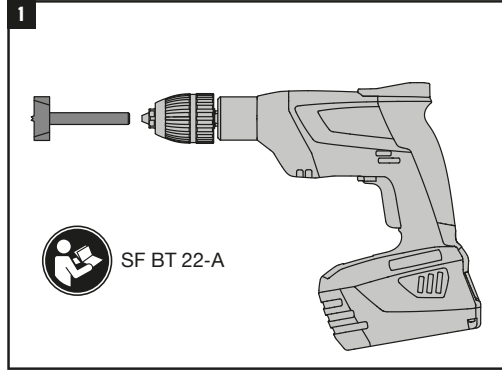
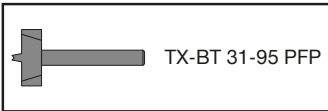
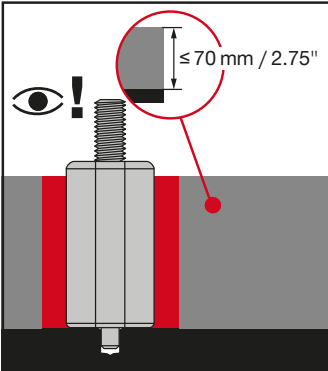

5.13 Chemical resistance of SN sealing washer

(X-BT sealing washer)

Chemicals	Volume swell					
	<20%	20-40%	>40-60%	60-80%	>80-100%	>100%
1. Water at 80°C	■					
2. Sea water	■					
3. Zinc chloride 10%	■					
4. Sodium chloride 15%	■					
5. Hydrochloric acid 10%	■					
6. Acetic acid	■					
7. Acrylonitrile				■		
8. Aniline				■		
9. n-Butyl acetate					■	
10. Diethylether		■				
11. Ethanol	■					
12. Glycerol	■					
13. n-Hexane	■					
14. Methanol	■					
15. Methylethylketone				■		
16. Nitrobenzene				■		
17. 1-Propanol	■					
18. Oil (ASTM-1) at 80°C	■					
19. Oil (ASTM-2) at 80°C		■				
20. Oil (ASTM-3) at 80°C		■				
21. Reference fuel B (isooctane/toluene, 70/30)				■		
22. Reference fuel C (isooctane/toluene, 50/50)					■	
23. Hydraulic brake fluid	■					
24. Hydraulic brake fluid at 100°C		■				
25. Antifreeze (ethylene glycol/water 50/50) at 125°C		■				

Material: 3.1107 Elastomer: CR ozone and UV resistance Temperature range: -40°C to +100°C

Volume swelling is a reaction of the material of the washer when it's in contact with the different substances. It's used as a parameter to describe the chemical reaction.

The swelling factor gives an indication of the behavior of the material, but swelling does not lead directly to loss of the sealing property. With an installed stud, the washer is compressed against the base steel.

Without any specific requirement it can be stated that the washer is resistant to all substances where the volume swelling value is not above 20 to 40%.



Hilti Corporation
9494 Schaan, Liechtenstein
P +423-234 0000

www.facebook.com/hiltigroup
www.hilti.group