



MFT-FOX-VTR-2L- HANGERS- UNDERCUT ANCHORS

Hilti facade system



CONTENT AND OVERVIEW

Panels	3
Application and Description	4
System Drawings	5-16
Brackets Range	
MFT-FOX VTR Medium	17
MFT-FOX VTR Large	18
Bracket Profile Adjustment	19
Products Range	20-21

MFT-FOX-VTR-2L-hangers-undercut anchors



Fiber-cement



HPL



Ceramic



Stone





APPLICATION AND DESCRIPTION

MFT-FOX-VTR-2L-hangers-undercut anchors

The system consists of stainless steel wall brackets and profiles, and is specifically designed for vertical substructures with undercut anchors for invisible fixing in ventilated facades. Wall brackets are supplied with an additional isolator pad and different hole geometries in the base plate which allow the usage of every standard Hilti anchor.

Wall brackets are designed with both fixed and flexible points to allow for thermal expansion of the profile. The fixed point takes the weight of the panels and substructure and the proportional wind loads, while the flexible point only assumes the proportional wind loads.

Vertical profiles are connected to the wall brackets with specially designed screws for fixed and flexible points. This allows virtually frictionless sliding of the profiles against the wall brackets and keeps the profile connected by the fixed point in place. The flexible point makes sure that there are no additional loads on the substructure by the profile's expansion forces.

With this system, wall tolerances of up to 40 mm can be perfectly compensated. The wall brackets are available from 120 mm to 300 mm in 20 mm increments, each in two different sizes (large and medium). The isolator pad separates the substructure from the base material to reduce thermal bridging.

The horizontal hanger profiles with elongated application will be fixed on the vertical profiles. Fix points will be realized with 2 screws in the elongated holes; flexible points with 1 screw. Hangers are available in three different variants – fix-hangers; leveling-hangers and leveling-hangers with a fixation hole to the hanger profile.

Advantages:

- Flexible design using fixed and flexible points
- Two different sizes of brackets (large and medium)
- Bracket length 120 – 300 mm
- Stainless Steel A4 material
- 40 mm adjustment capability of the profiles in the wall brackets
- Brackets can be mounted with every standard Hilti anchor
- The isolator separates the substructure from the base material to reduce thermal bridging
- Substructures can be designed with PROFIS Façade to generate technically-sound and economically-optimised solutions
- Can be used with all common cladding materials

VIEW OF CLADDING

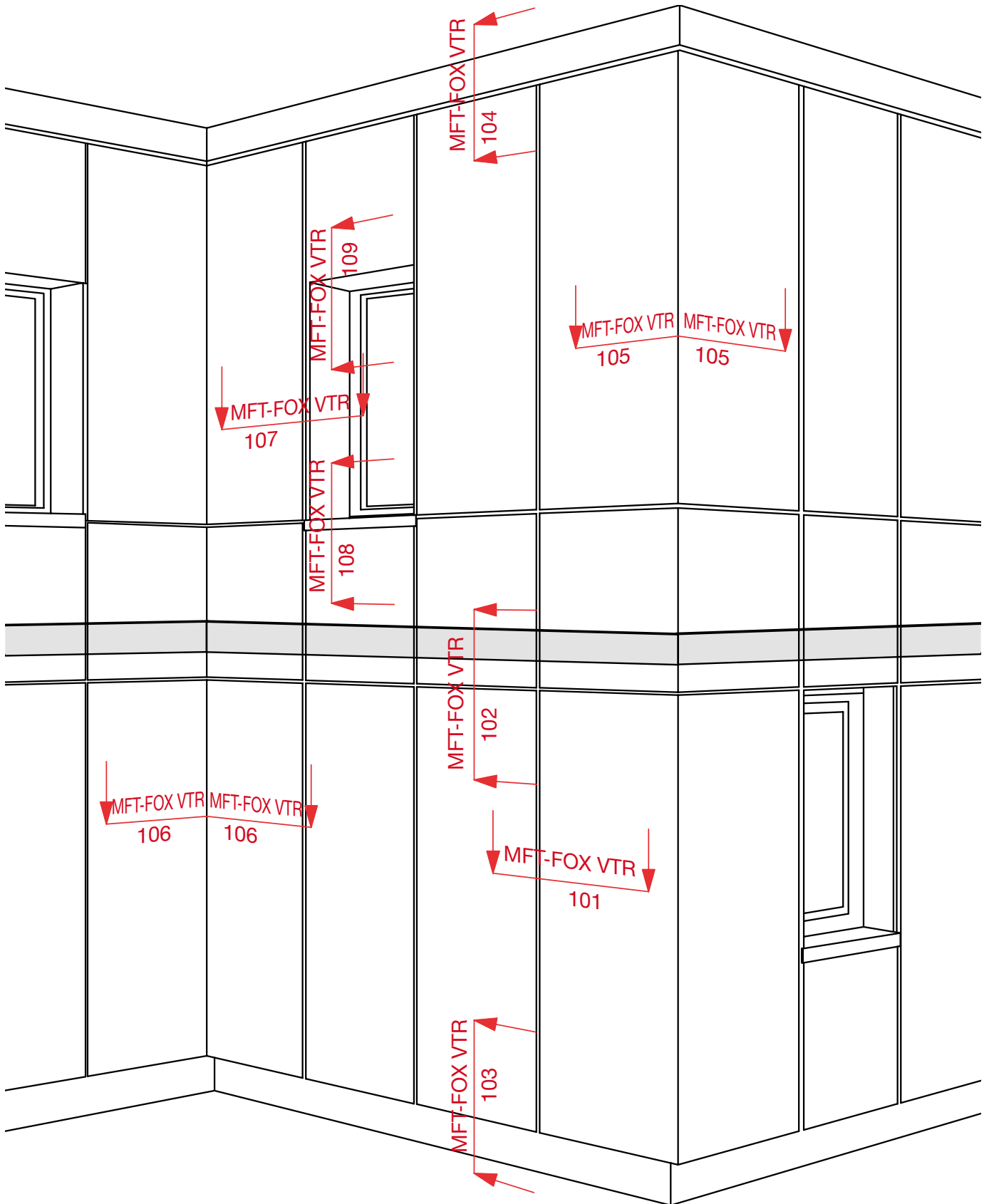

This is an interactive page! By clicking on a system part you get directed to the respective detail page.
Click on the move-back button to jump back to the CONTENT AND OVERVIEW.

MFT-FOX VTR 101

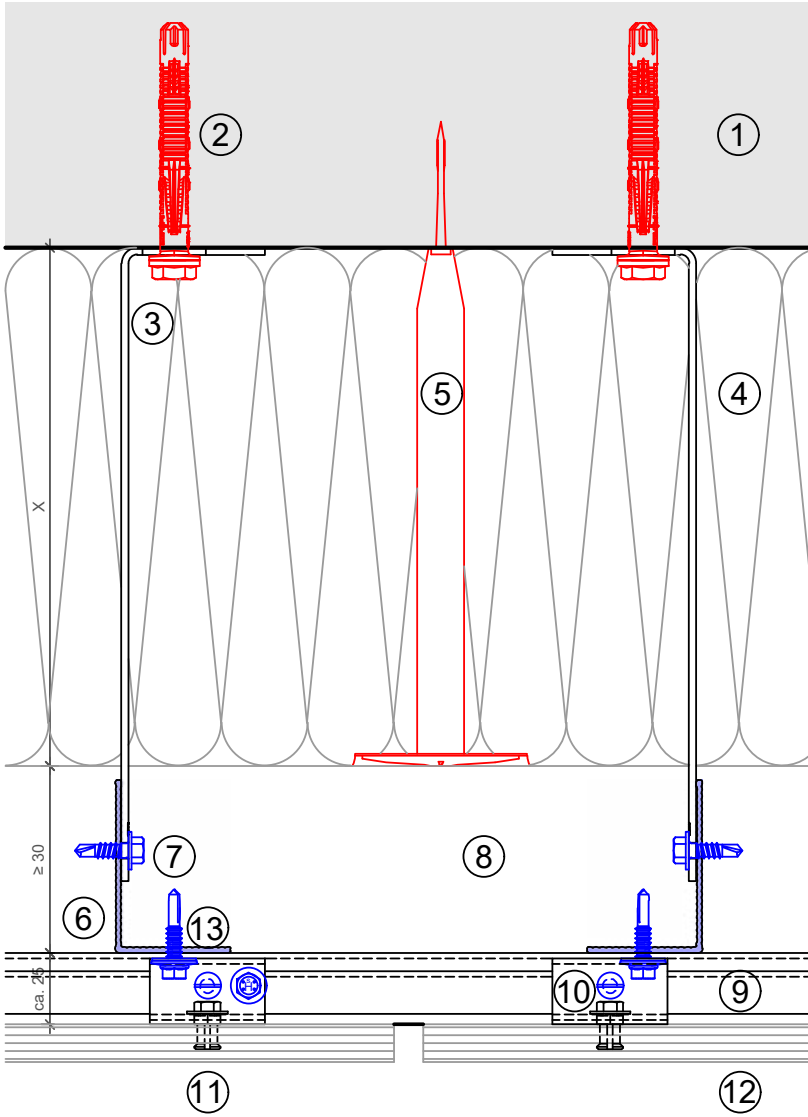

- Legend:
- ① Base material
 - ② Anchor acc. to static
 - ③ Bracket
 - ④ Insulation
 - ⑤ Insulation fastener
 - ⑥ Profile
 - ⑦ Self drilling screw
 - ⑧ Ventilation gap
 - ⑨ Load-bearing hanger profile
 - ⑩ Hanger
 - ⑪ Cladding fixing
 - ⑫ Cladding
 - ⑬ Profile fastener

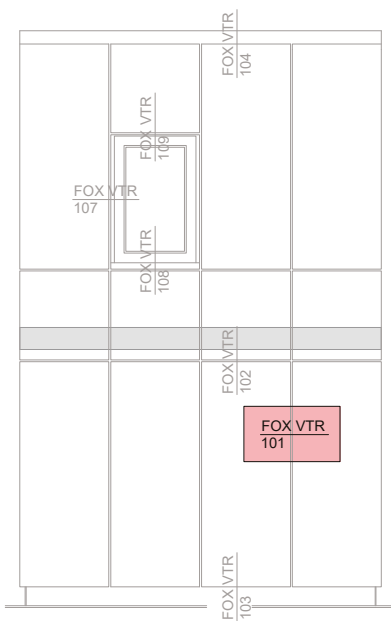

This is an interactive page! Click on the move-back button to jump back to the VIEW OF CLADDING.

MFT-FOX VTR 102

Legend:

- ① Base material
- ② Anchor acc. to static
- ③ Bracket
- ④ Insulation
- ⑤ Insulation fastener
- ⑥ Profile
- ⑦ Self drilling screw
- ⑧ Ventilation gap
- ⑨ Load-bearing hanger profile
- ⑩ Hanger
- ⑪ Cladding fixing
- ⑫ Cladding

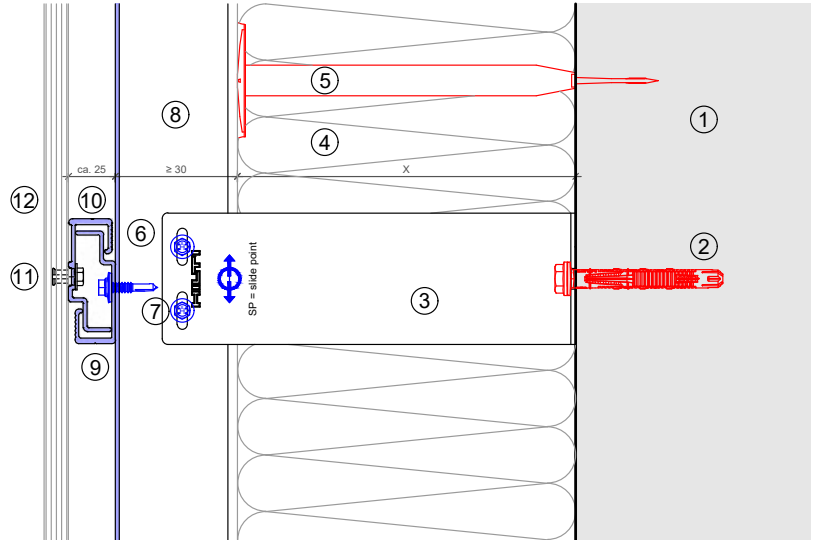

Vertical section-fixed point

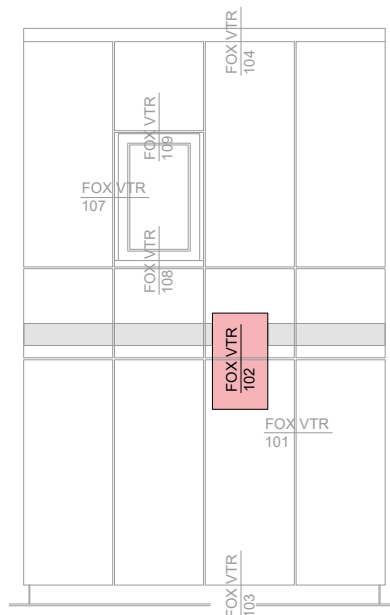
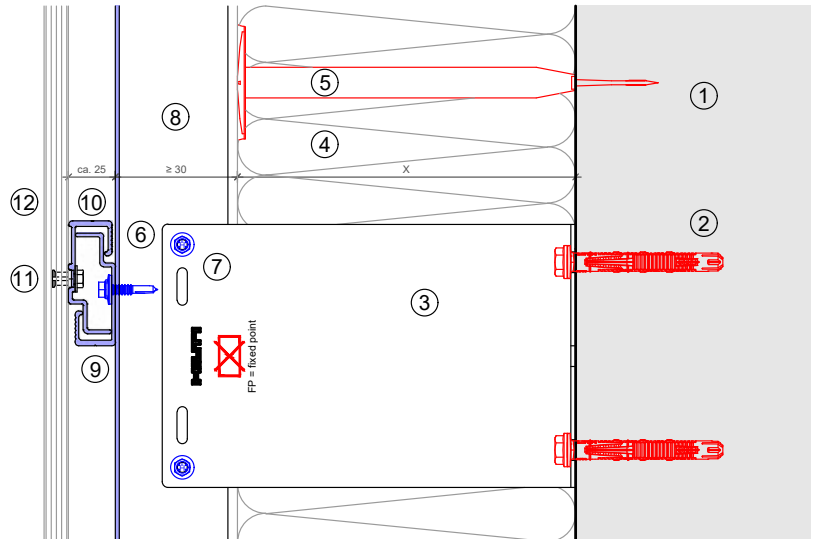

This is an interactive page! Click on the move-back button to jump back to the VIEW OF CLADDING.



MFT-FOX VTR 102

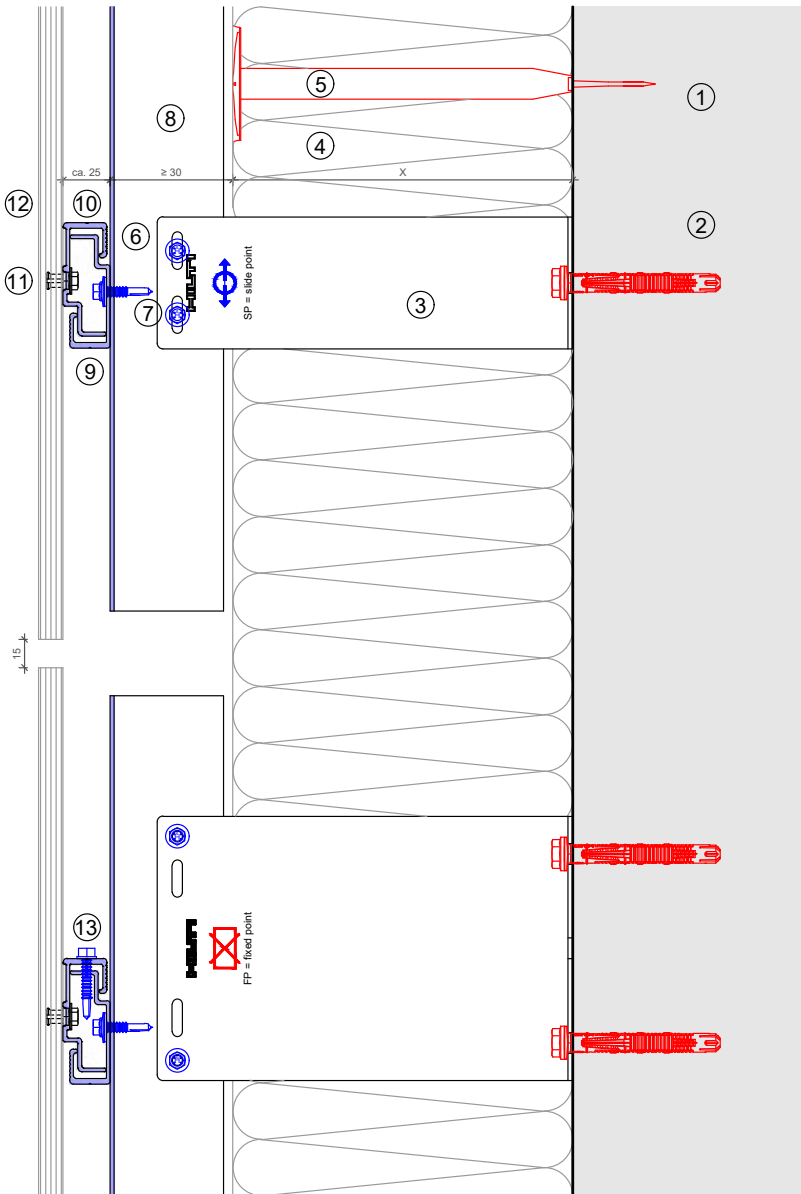

Legend:

- ① Base material
- ② Anchor acc. to static
- ③ Bracket
- ④ Insulation
- ⑤ Insulation fastener
- ⑥ Profile
- ⑦ Self drilling screw
- ⑧ Ventilation gap
- ⑨ Load-bearing hanger profile
- ⑩ Hanger
- ⑪ Cladding fixing
- ⑫ Cladding
- ⑬ Profile fastener

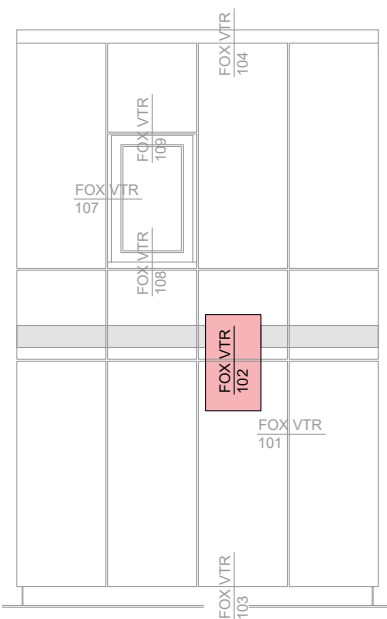

This is an interactive page! Click on the move-back button to jump back to the VIEW OF CLADDING.

MFT-FOX VTR 103

Legend:

- ① Base material
- ② Anchor acc. to static
- ③ Bracket
- ④ Insulation
- ⑤ Insulation fastener
- ⑥ Profile
- ⑦ Self drilling screw
- ⑧ Ventilation gap
- ⑨ Load-bearing hanger profile
- ⑩ Hanger
- ⑪ Cladding fixing
- ⑫ Cladding

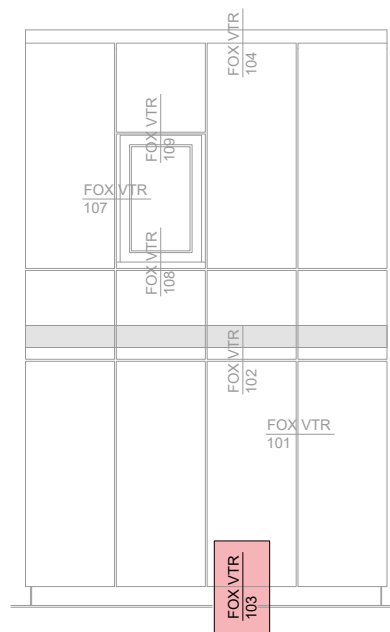
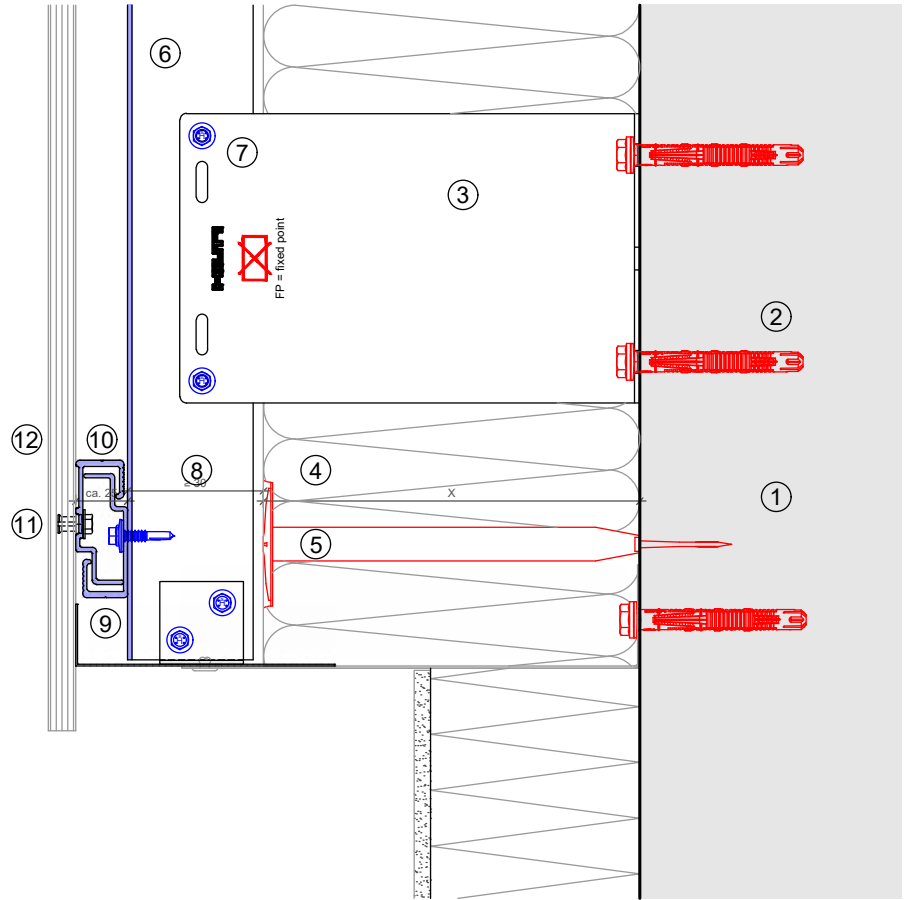

This is an interactive page! Click on the move-back button to jump back to the VIEW OF CLADDING.



MFT-FOX VTR 104

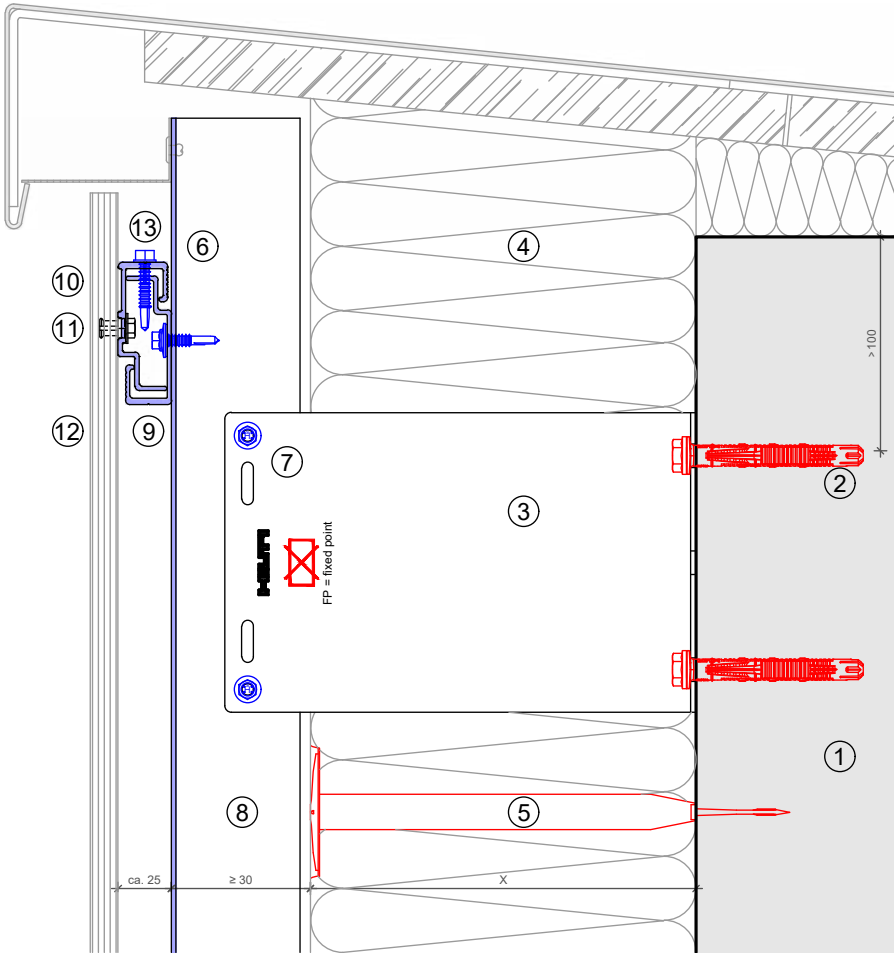

Legend:

- ① Base material
- ② Anchor acc. to static
- ③ Bracket
- ④ Insulation
- ⑤ Insulation fastener
- ⑥ Profile
- ⑦ Self drilling screw
- ⑧ Ventilation gap
- ⑨ Load-bearing hanger profile
- ⑩ Hanger
- ⑪ Cladding fixing
- ⑫ Cladding
- ⑬ Profile fastener

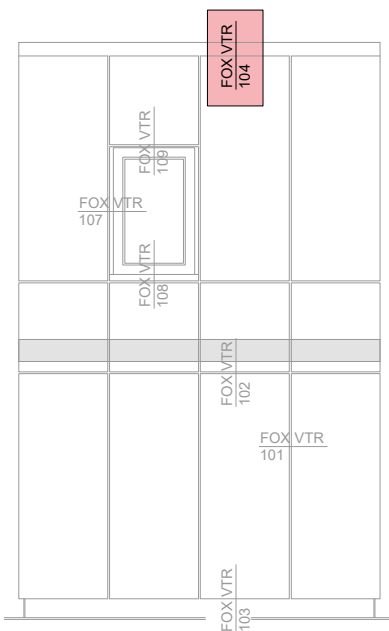

This is an interactive page! Click on the move-back button to jump back to the VIEW OF CLADDING.

MFT-FOX VTR 105

Legend:

- ① Base material
- ② Anchor acc. to static
- ③ Bracket
- ④ Insulation
- ⑤ Insulation fastener
- ⑥ Profile
- ⑦ Self drilling screw
- ⑧ Ventilation gap
- ⑨ Load-bearing hanger profile
- ⑩ Hanger
- ⑪ Cladding fixing
- ⑫ Cladding
- ⑬ Profile fastener

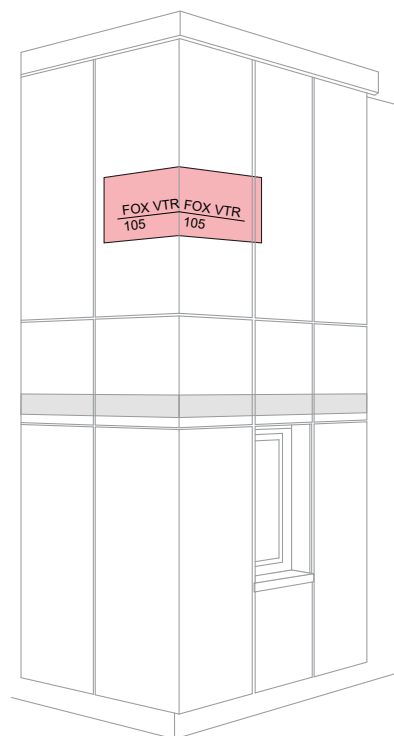
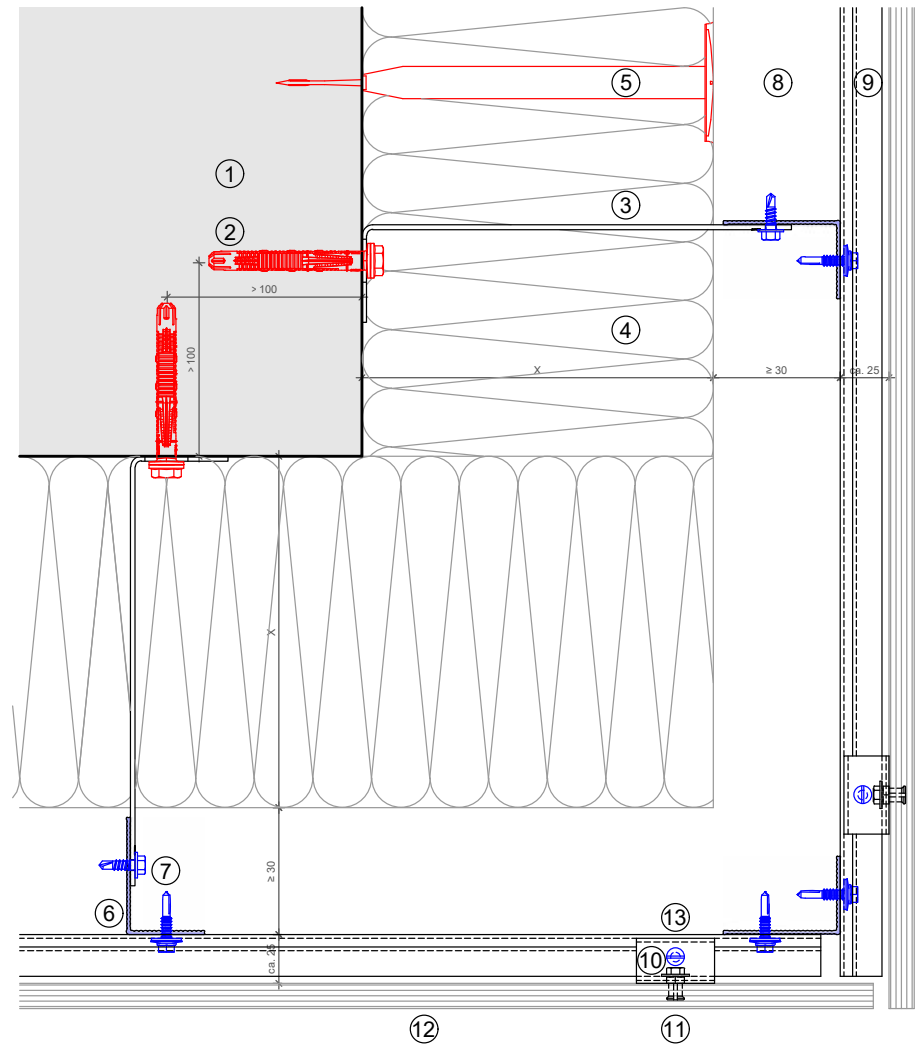

This is an interactive page! Click on the move-back button to jump back to the VIEW OF CLADDING.



MFT-FOX VTR 106

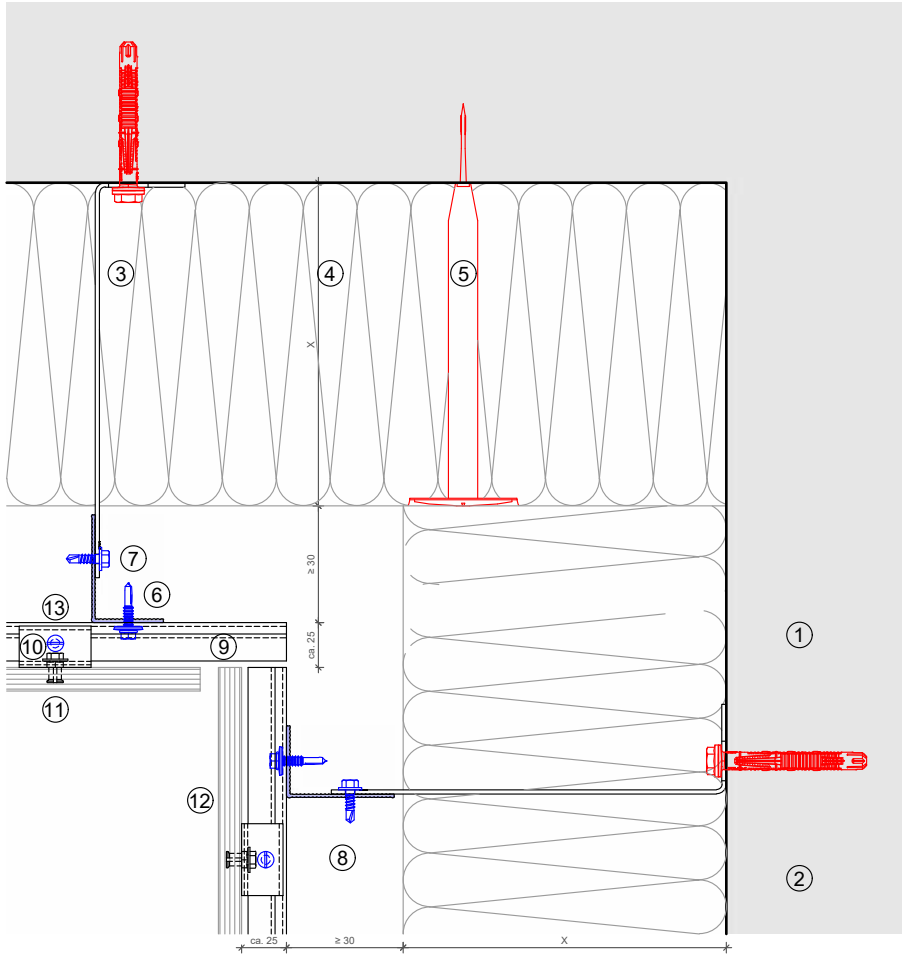

- Legend:
- ① Base material
 - ② Anchor acc. to static
 - ③ Bracket
 - ④ Insulation
 - ⑤ Insulation fastener
 - ⑥ Profile
 - ⑦ Self drilling screw
 - ⑧ Ventilation gap
 - ⑨ Load-bearing hanger profile
 - ⑩ Hanger
 - ⑪ Cladding fixing
 - ⑫ Cladding
 - ⑬ Profile fastener

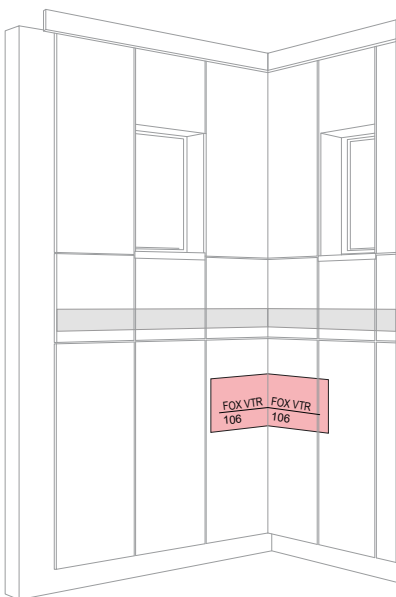

This is an interactive page! Click on the move-back button to jump back to the VIEW OF CLADDING.

MFT-FOX VTR 107

Legend:

- ① Base material
- ② Anchor acc. to static
- ③ Bracket
- ④ Insulation
- ⑤ Insulation fastener
- ⑥ Profile
- ⑦ Self drilling screw
- ⑧ Ventilation gap
- ⑨ Load-bearing hanger profile
- ⑩ Hanger
- ⑪ Cladding fixing
- ⑫ Cladding
- ⑬ Profile fastener

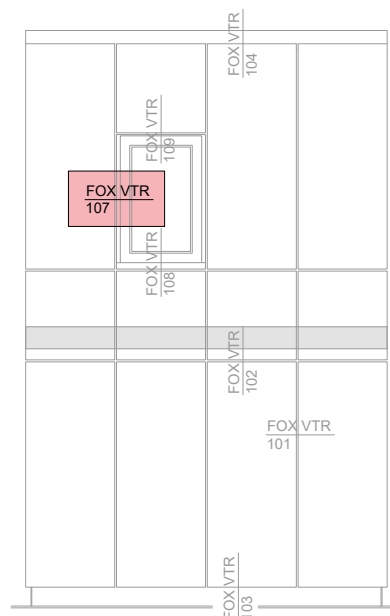
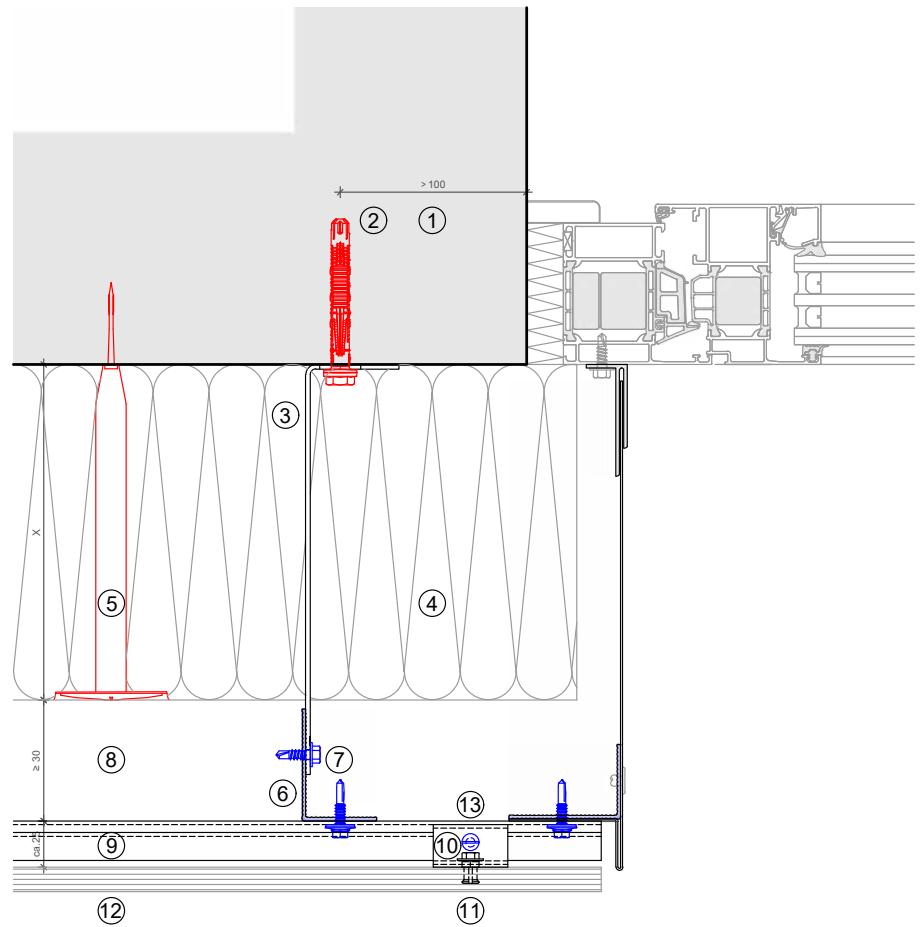

This is an interactive page! Click on the move-back button to jump back to the VIEW OF CLADDING.



MFT-FOX VTR 108

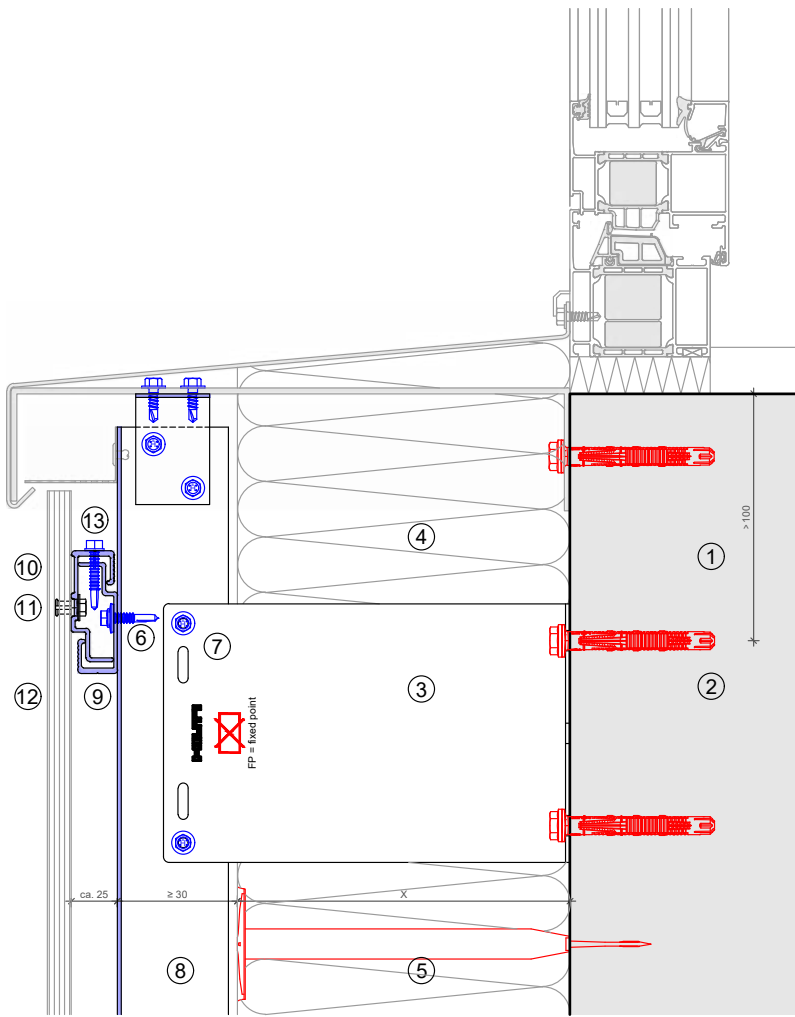

Legend:

- ① Base material
- ② Anchor acc. to static
- ③ Bracket
- ④ Insulation
- ⑤ Insulation fastener
- ⑥ Profile
- ⑦ Self drilling screw
- ⑧ Ventilation gap
- ⑨ Load-bearing hanger profile
- ⑩ Hanger
- ⑪ Cladding fixing
- ⑫ Cladding
- ⑬ Profile fastener

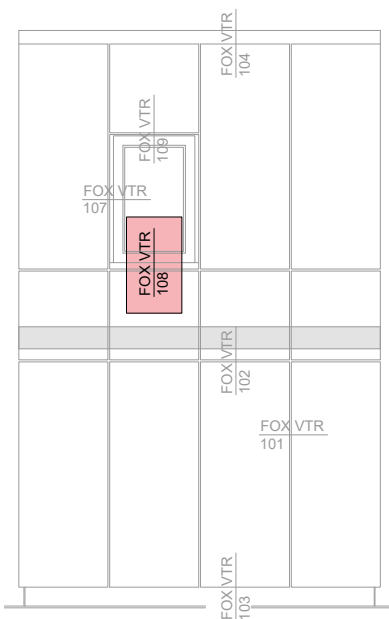

This is an interactive page! Click on the move-back button to jump back to the VIEW OF CLADDING.

MFT-FOX VTR 109

Legend:

- ① Base material
- ② Anchor acc. to static
- ③ Bracket
- ④ Insulation
- ⑤ Insulation fastener
- ⑥ Profile
- ⑦ Self drilling screw
- ⑧ Ventilation gap
- ⑨ Load-bearing hanger profile
- ⑩ Hanger
- ⑪ Cladding fixing
- ⑫ Cladding

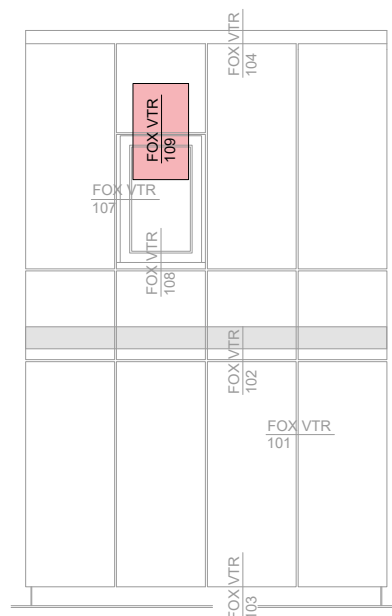
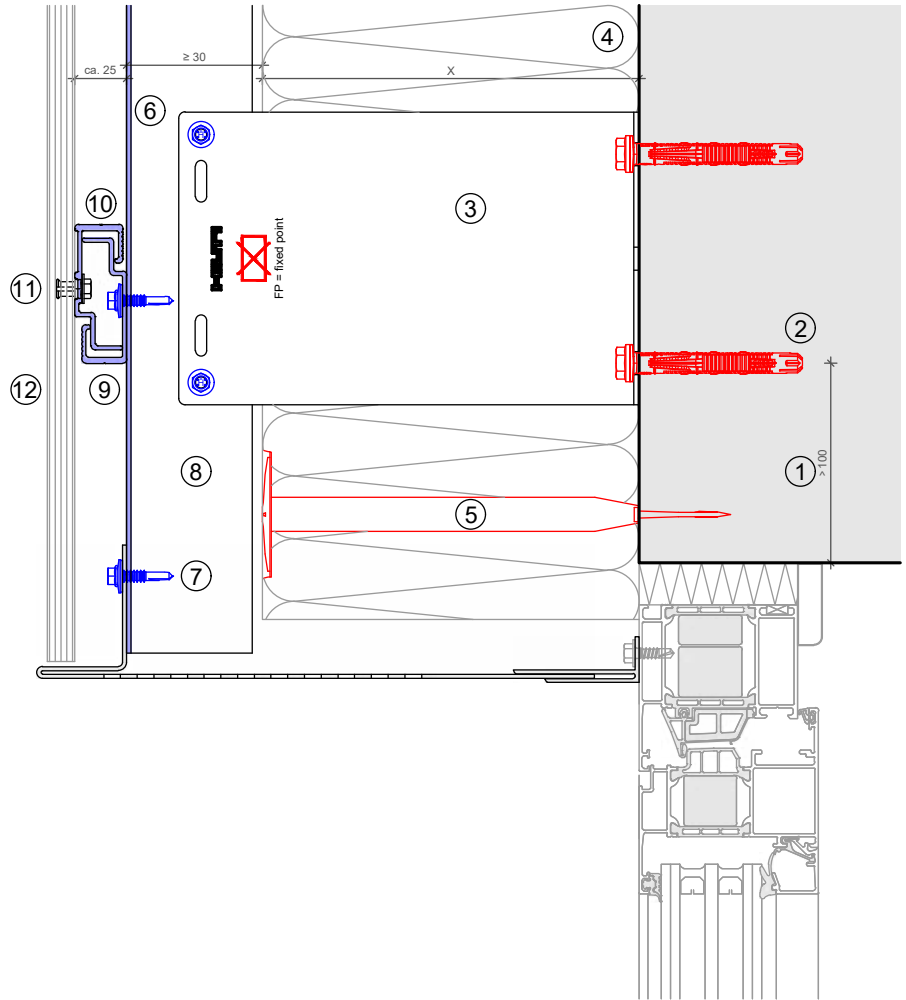

This is an interactive page! Click on the move-back button to jump back to the VIEW OF CLADDING.



MFT-FOX VTR 109

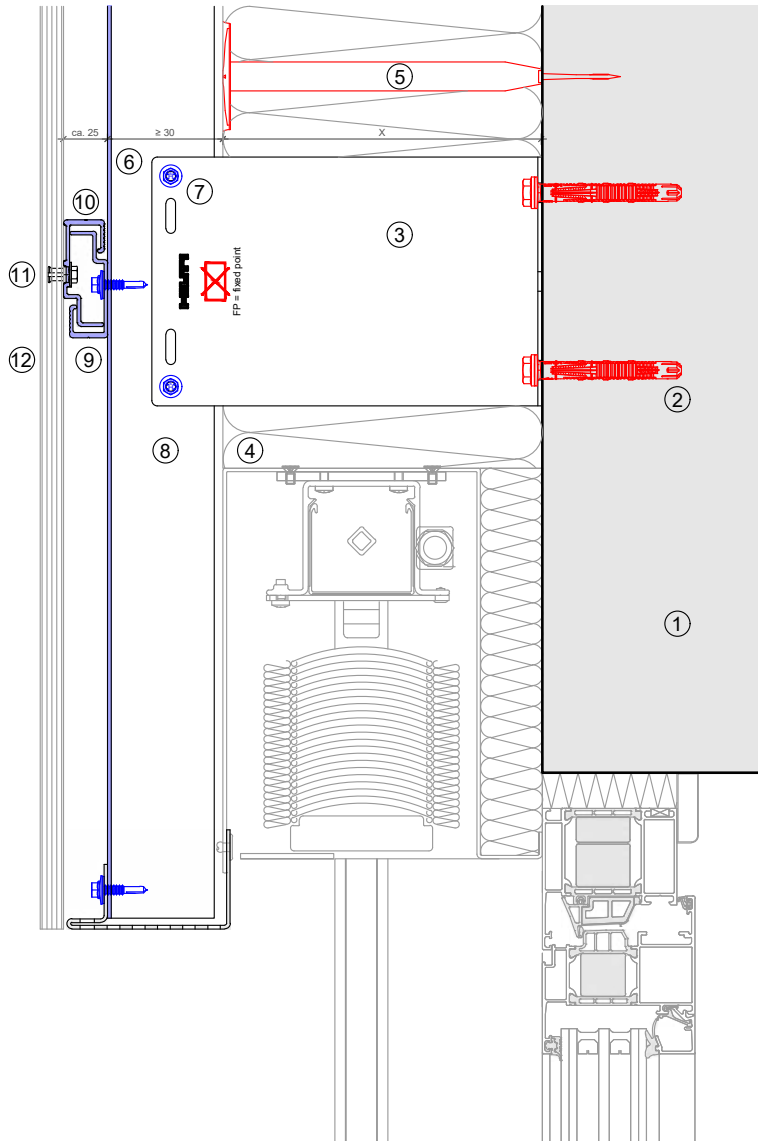

Legend:

- ① Base material
- ② Anchor acc. to static
- ③ Bracket
- ④ Insulation
- ⑤ Insulation fastener
- ⑥ Profile
- ⑦ Self drilling screw
- ⑧ Ventilation gap
- ⑨ Load-bearing hanger profile
- ⑩ Hanger
- ⑪ Cladding fixing
- ⑫ Cladding

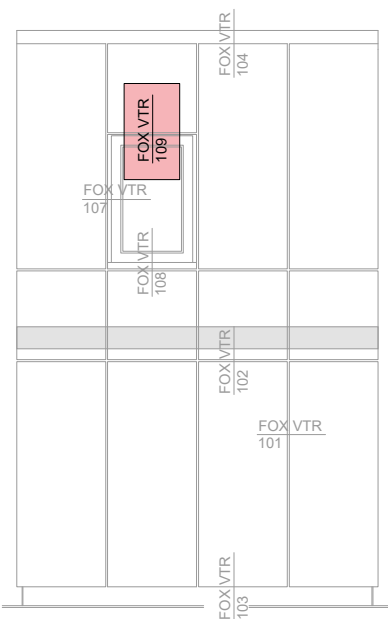

This is an interactive page! Click on the move-back button to jump back to the VIEW OF CLADDING.

BRACKETS RANGE

MFT-FOX VTR Medium SP

Order Description	Item No.	Length
ANCHORS D=11 mm		
MFT-FOX VTR SP 60 M 11	2239871	60 mm
MFT-FOX VTR SP 80 M 11	2239872	80 mm
MFT-FOX VTR SP 100 M 11	2239873	100 mm
MFT-FOX VTR SP 120 M 11	2187437	120 mm
MFT-FOX VTR SP 140 M 11	2187438	140 mm
MFT-FOX VTR SP 160 M 11	2187439	160 mm
MFT-FOX VTR SP 180 M 11	2187440	180 mm
MFT-FOX VTR SP 200 M 11	2187441	200 mm
MFT-FOX VTR SP 220 M 11	2187442	220 mm
MFT-FOX VTR SP 240 M 11	2187443	240 mm
MFT-FOX VTR SP 260 M 11	2187444	260 mm
MFT-FOX VTR SP 280 M 11	2187445	280 mm
MFT-FOX VTR SP 300 M 11	2187446	300 mm

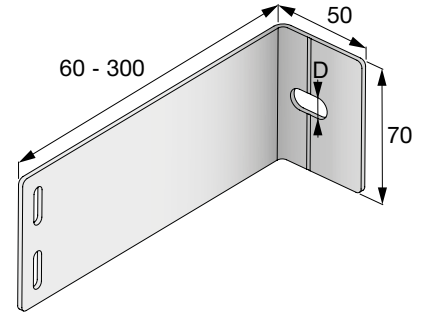

MFT-FOX VTR Medium FP

Order Description	Item No.	Length
ANCHORS D=11 mm		
MFT-FOX VTR FP 60 M 11	2239874	60 mm
MFT-FOX VTR FP 80 M 11	2239875	80 mm
MFT-FOX VTR FP 100 M 11	2239876	100 mm
MFT-FOX VTR FP 120 M 11	2239877	120 mm
MFT-FOX VTR FP 140 M 11	2239878	140 mm
MFT-FOX VTR FP 160 M 11	2239879	160 mm
MFT-FOX VTR FP 180 M 11	2239880	180 mm
MFT-FOX VTR FP 200 M 11	2239881	200 mm
MFT-FOX VTR FP 220 M 11	2239882	220 mm
MFT-FOX VTR FP 240 M 11	2239883	240 mm
MFT-FOX VTR FP 260 M 11	2239884	260 mm
MFT-FOX VTR FP 280 M 11	2239566	280 mm
MFT-FOX VTR FP 300 M 11	2239567	300 mm

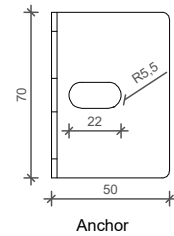

BRACKETS RANGE

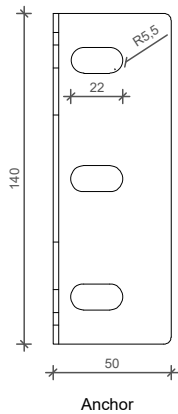
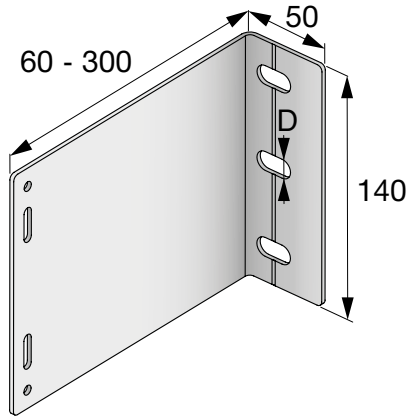

MFT-FOX VTR Large

Order Description	Item No.	Length
ANCHORS D=11 mm		
MFT-FOX VTR 60 L 11	2239568	60 mm
MFT-FOX VTR 80 L 11	2239569	80 mm
MFT-FOX VTR 100 L 11	2239870	100 mm
MFT-FOX VTR 120 L 11	2186947	120 mm
MFT-FOX VTR 140 L 11	2186948	140 mm
MFT-FOX VTR 160 L 11	2186949	160 mm
MFT-FOX VTR 180 L 11	2187430	180 mm
MFT-FOX VTR 200 L 11	2187431	200 mm
MFT-FOX VTR 220 L 11	2187432	220 mm
MFT-FOX VTR 240 L 11	2187433	240 mm
MFT-FOX VTR 260 L 11	2187434	260 mm
MFT-FOX VTR 280 L 11	2187435	280 mm
MFT-FOX VTR 300 L 11	2187436	300 mm

BRACKET PROFILE ADJUSTMENT

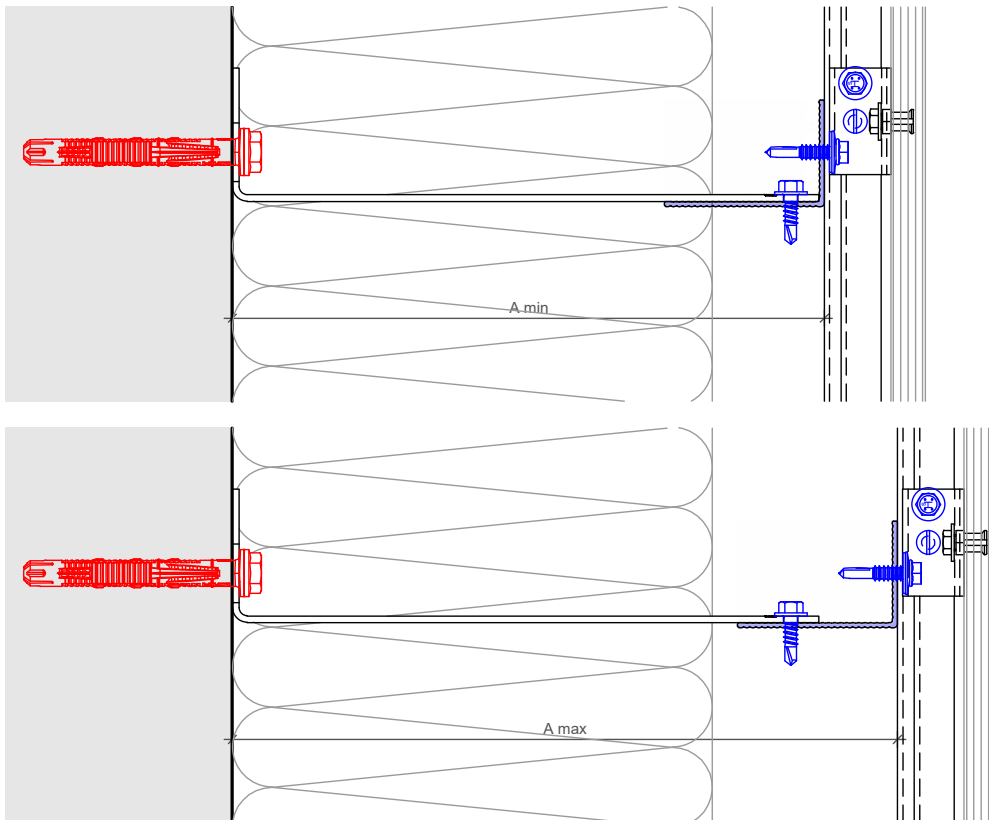

Profiles	MFT-T 60x80x1,8 6m 60x100x1,8 6m 60x120x1,8 6m		MFT-T 40x80x1,8 6m		MFT-L 60x40x1,8 6m		MFT-L 40x40x1,8 6m	
	A min*	A max*	A min*	A max*	A min*	A max*	A min*	A max*
Brackets								
MFT-FOX VTR 60 M/L 11	61.8	101.8	61.8	81.8	60	101.8	60	81.8
MFT-FOX VTR 80 M/L 11	81.8	121.8	81.8	101.8	80	121.8	80	101.8
MFT-FOX VTR 100 M/L 11	101.8	141.8	101.8	121.8	100	141.8	100	121.8
MFT-FOX VTR 120 M/L 11	121.8	161.8	121.8	141.8	120	161.8	120	141.8
MFT-FOX VTR 140 M/L 11	141.8	181.8	141.8	161.8	140	181.8	140	161.8
MFT-FOX VTR 160 M/L 11	161.8	201.8	161.8	181.8	160	201.8	160	181.8
MFT-FOX VTR 180 M/L 11	181.8	221.8	181.8	201.8	180	221.8	180	201.8
MFT-FOX VTR 200 M/L 11	201.8	241.8	201.8	221.8	200	241.8	200	221.8
MFT-FOX VTR 220 M/L 11	221.8	261.8	221.8	241.8	220	261.8	220	241.8
MFT-FOX VTR 240 M/L 11	241.8	281.8	241.8	261.8	240	281.8	240	261.8
MFT-FOX VTR 260 M/L 11	261.8	301.8	261.8	181.8	260	301.8	260	181.8
MFT-FOX VTR 280 M/L 11	281.8	321.8	281.8	301.8	280	321.8	280	301.8
MFT-FOX VTR 300 M/L 11	301.8	341.8	301.8	321.8	300	341.8	300	321.8

* The distance shown is valid for profile thickness of 1,8 mm..



PRODUCTS RANGE

Bracket fasteners

HUS-HR



HRD-H



HST-R



HSA-R



HIT-HY 270



HIT-HY 200-A



S-MP 53S



S-MD 51S / S-MD 53S / S-MD 55S



Direct fastening



Brackets

MFT-FOX-VTR Medium



MFT-FOX-VTR Large



PRODUCTS RANGE

Profiles

MFT-L



MFT-T



MFT-HP



Profile fastener

S-AD



Accessories

MFT-ISO



MFT-H



Insulation fasteners

Insulation fasteners

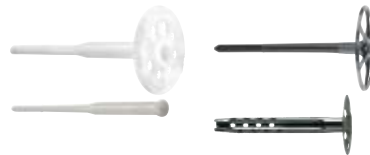



Hilti Corporation
9494 Schaan Liechtenstein
P +423-234 2111

www.facebook.com/hiltigroup
www.hilti.group